

GT STRUDL® CAD Modeler Getting Started Guide



PROCESS, POWER & MARINE

CAD Modeler Getting Started Guide

Release Date: February 2015



Notice

This GT STRUDL CAD Modeler Getting Started Guide is applicable to GT STRUDL Version 2015 and later versions for use on PCs under the Microsoft Windows 8, Windows 7 and Windows Vista operating systems.

Copyright

Copyright © 2015 Intergraph® Corporation. All Rights Reserved. Intergraph is part of **Hexagon**.

Including software, file formats, and audiovisual displays; may be used pursuant to applicable software license agreement; contains confidential and proprietary information of Intergraph and/or third parties which is protected by copyright law, trade secret law, and international treaty, and may not be provided or otherwise made available without proper authorization from Intergraph Corporation.

U.S. Government Restricted Rights Legend

Use, duplication, or disclosure by the government is subject to restrictions as set forth below. For civilian agencies: This was developed at private expense and is "restricted computer software" submitted with restricted rights in accordance with subparagraphs (a) through (d) of the Commercial Computer Software - Restricted Rights clause at 52.227-19 of the Federal Acquisition Regulations ("FAR") and its successors, and is unpublished and all rights are reserved under the copyright laws of the United States. For units of the Department of Defense ("DoD"): This is "commercial computer software" as defined at DFARS 252.227-7014 and the rights of the Government are as specified at DFARS 227.7202-3.

Unpublished - rights reserved under the copyright laws of the United States.

Intergraph Corporation
300 Intergraph Way
Huntsville, AL 35813

Documentation

Documentation shall mean, whether in electronic or printed form, User's Guides, Installation Guides, Reference Manuals, Reference Guides, Administrator's Guides, Customization Guides, Programmer's Guides, Configuration Guides and Help Guides delivered with a particular software product.

Other Documentation

Other Documentation shall mean, whether in electronic or printed form and delivered with software or on eCustomer, SharePoint, or box.net, any documentation related to work processes, workflows, and best practices that is provided by Intergraph as guidance for using a software product.

Terms of Use

a. Use of a software product and Documentation is subject to the End User License Agreement ("EULA") delivered with the software product unless the Licensee has a valid signed license for this software product with Intergraph Corporation. If the Licensee has a valid signed license for this software product with Intergraph Corporation, the valid signed license shall take precedence and govern the use of this software product and Documentation. Subject to the terms contained within the applicable license agreement, Intergraph Corporation gives Licensee permission to print a reasonable number of copies of the Documentation as defined in the applicable license agreement and delivered with the software product for Licensee's internal, non-commercial use. The Documentation may not be printed for resale or redistribution.

b. For use of Documentation or Other Documentation where end user does not receive a EULA or does not have a valid license agreement with Intergraph, Intergraph grants the Licensee a non-exclusive license to use the Documentation or Other Documentation for Licensee's internal non-commercial use. Intergraph Corporation gives Licensee permission to print a reasonable number of copies of Other Documentation for Licensee's internal, non-commercial. The Other Documentation may not be printed for resale or redistribution. This license contained in this subsection b) may be terminated at any time and for any reason by Intergraph Corporation by giving written notice to Licensee.

Disclaimer of Warranties

Except for any express warranties as may be stated in the EULA or separate license or separate terms and conditions, Intergraph Corporation disclaims any and all express or implied warranties including, but not limited to the implied warranties of merchantability and fitness for a particular purpose and nothing stated in, or implied by, this document or its contents shall be considered or deemed a modification or amendment of such disclaimer. Intergraph believes the information in this publication is accurate as of its publication date.

The information and the software discussed in this document are subject to change without notice and are subject to applicable technical product descriptions. Intergraph Corporation is not responsible for any error that may appear in this document.

The software, Documentation and Other Documentation discussed in this document are furnished under a license and may be used or copied only in accordance with the terms of this license. THE USER OF THE SOFTWARE IS EXPECTED TO MAKE THE FINAL EVALUATION AS TO THE USEFULNESS OF THE SOFTWARE IN HIS OWN ENVIRONMENT.

Intergraph is not responsible for the accuracy of delivered data including, but not limited to, catalog, reference and symbol data. Users should verify for themselves that the data is accurate and suitable for their project work.

Limitation of Damages

IN NO EVENT WILL INTERGRAPH CORPORATION BE LIABLE FOR ANY DIRECT, INDIRECT, CONSEQUENTIAL INCIDENTAL, SPECIAL, OR PUNITIVE DAMAGES, INCLUDING BUT NOT LIMITED TO, LOSS OF USE OR PRODUCTION, LOSS OF REVENUE OR PROFIT, LOSS OF DATA, OR CLAIMS OF THIRD PARTIES, EVEN IF INTERGRAPH CORPORATION HAS BEEN ADVISED OF THE POSSIBILITY OF SUCH DAMAGES.

UNDER NO CIRCUMSTANCES SHALL INTERGRAPH CORPORATION'S LIABILITY EXCEED THE AMOUNT THAT INTERGRAPH CORPORATION HAS BEEN PAID BY LICENSEE UNDER THIS AGREEMENT AT THE TIME THE CLAIM IS MADE. EXCEPT WHERE PROHIBITED BY APPLICABLE LAW, NO CLAIM, REGARDLESS OF FORM, ARISING OUT OF OR IN CONNECTION WITH THE SUBJECT MATTER OF THIS DOCUMENT MAY BE BROUGHT BY LICENSEE MORE THAN TWO (2) YEARS AFTER THE EVENT GIVING RISE TO THE CAUSE OF ACTION HAS OCCURRED.

IF UNDER THE LAW RULED APPLICABLE ANY PART OF THIS SECTION IS INVALID, THEN INTERGRAPH LIMITS ITS LIABILITY TO THE MAXIMUM EXTENT ALLOWED BY SAID LAW.

Export Controls

Intergraph Corporation's software products and any third-party Software Products obtained from Intergraph Corporation, its subsidiaries, or distributors (including any Documentation, Other Documentation or technical data related to these products) are subject to the export control laws and regulations of the United States. Diversion contrary to U.S. law is prohibited. These Software Products, and the direct product thereof, must not be exported or re-exported, directly or indirectly (including via remote access) under the following circumstances:

- a. To Cuba, Iran, North Korea, Sudan, or Syria, or any national of these countries.
- b. To any person or entity listed on any U.S. government denial list, including but not limited to, the U.S. Department of Commerce Denied Persons, Entities, and Unverified Lists, <http://www.bis.doc.gov/complianceandenforcement/liststocheck.htm>, the U.S. Department of Treasury Specially Designated Nationals List, <http://www.treas.gov/offices/enforcement/ofac/>, and the U.S. Department of State Debarred List, <http://www.pmdtc.state.gov/compliance/debar.html>.
- c. To any entity when Licensee knows, or has reason to know, the end use of the Software Product is related to the design, development, production, or use of missiles, chemical, biological, or nuclear weapons, or other un-safeguarded or sensitive nuclear uses.
- d. To any entity when Licensee knows, or has reason to know, that an illegal reshipment will take place.

Any questions regarding export or re-export of these Software Products should be addressed to Intergraph Corporation's Export Compliance Department, Huntsville, Alabama 35894, USA.

Trademarks

Intergraph, the Intergraph logo, and GT STRUDL are trademarks or registered trademarks of Intergraph Corporation or its subsidiaries in the United States and other countries. Microsoft, Windows, Windows 8, Windows 7 and Windows Vista are registered trademarks of Microsoft Corporation. AutoCAD is a registered trademark of Autodesk Corporation. Other brands and product names are trademarks of their respective owners.

Table of Contents

NOTICES	iii
Table of Contents	v
1. Getting Started	1
1.1. Introduction.....	1
1.2. Installing CAD Modeler under Windows 8/7/Vista	1
2. Using CAD Modeler	5
2.1. Overview of Using CAD Modeler and configuring AutoCAD	5
2.2. Running CAD Modeler	5
2.3. Menu Bar and Ribbon Area	6
2.4. AutoCAD Commands	7
2.5. CAD Modeler Commands	8
2.5.1. Units.....	8
2.5.2. Materials.....	8
2.5.3. Sections	9
2.5.4. Levels	10
2.5.5. Grid	11
2.5.6. Creating Joints	13
2.5.7. Finding Joints	14
2.5.8. Joint Supports.....	14
2.5.9. Joint Properties.....	14
2.5.10. Duplicate Joints	15
2.5.11. Floating Joints.....	16
2.5.12. Creating Members.....	16
2.5.13. Finding Members.....	17
2.5.14. Splitting Members	17
2.5.15. Merging Members	17
2.5.16. Member Properties	17
2.5.17. Creating Shell Finite Elements.....	18
2.5.18. Finding Shells	18
2.5.19. Shell Properties.....	19
2.5.20. Meshing along a curve.....	19

2.5.21.	Meshing between two lines	21
2.5.22.	Meshing between four lines.....	22
2.5.23.	Meshing inside a polyline	22
2.5.24.	Meshing by extruding a polyline	24
2.5.25.	Meshing using 3 curves	24
2.5.26.	Groups	24
2.5.27.	Self - Weight	25
2.5.28.	Load Cases	26
2.5.29.	Joint Loads	27
2.5.30.	Member Loads.....	28
2.5.31.	Shell Loads	31
2.5.32.	Area Load.....	31
2.5.33.	Load Combinations.....	32
2.5.34.	Create GTI.....	33
2.5.35.	Edit GTI	34
2.5.36.	Execute GT STRUDL URDL.....	34
2.5.37.	Read Analysis Results	34
2.5.38.	Import GTI.....	36
2.5.39.	Set Views	36
2.5.40.	3D or Wireframe View of the Structure	36
2.5.41.	Colors and Visible Elements	37
2.5.42.	Display Options.....	38
2.5.43.	Annotate	39
2.5.44.	Select CAD Modeler's entities	40
2.5.45.	Display Deformed Structure	41
2.5.46.	Display Joint Loads	41
2.5.47.	Display Member Loads	41
2.5.48.	Display Member Diagrams	42
2.5.49.	Display Finite Element Results.....	42
2.5.50.	Display Member Code Check Results	42
2.5.51.	Clear Results Layer.....	43
2.5.52.	Version.....	43
3.	Tutorial Example #1.....	44

3.1.	Introduction.....	44
3.2.	Open CAD Modeler and start working	44
3.3.	Define the basic geometry of the model.....	45
3.4.	Create the 1 st floor.....	49
3.5.	Create the 2 nd floor.....	58
3.6.	Create the 3 rd floor	59
3.7.	Create bracing	62
3.8.	Create girders	67
3.9.	Create an opening	73
3.10.	Create Supports.....	74
3.11.	Check the model.....	75
3.12.	Define Groups.....	75
3.13.	Define Loads	78
3.14.	GT STRUDL Input File.....	86
3.15.	Display Results.....	89
4.	Tutorial Example #2.....	92
4.1.	Introduction.....	92
4.2.	Open CAD Modeler and start working	93
4.3.	Define the basic geometry of the model.....	93
4.4.	Create the bottom of the tank	96
4.5.	Create the walls of the tank	98
4.6.	Create Supports.....	104
4.7.	Check the model.....	106
4.8.	Define Groups.....	106
4.9.	Define Loads	109
4.10.	Create GT STRUDL Input File	114
4.11.	Display Results.....	117
5.	Appendix – List of Commands	121

GT STRUDL® CAD MODELER

Getting Started Guide

1. Getting Started

CAD Modeler is an add-on to AutoCAD®, which allows you to create GT STRUDL Input Files (GTI) graphically using AutoCAD's powerful CAD tools and graphical display capabilities. AutoCAD® must be installed in your computer before installing and running CAD Modeler. It is highly recommended that you have AutoCAD experience before using CAD Modeler.

1.1. Introduction

This document contains information about:

- Installing CAD Modeler
- Configuring AutoCAD and running CAD Modeler for first time
- List of CAD Modeler Functions with detailed explanation for each one
- Tutorial examples
- Summary of CAD Modeler commands

1.2. Installing CAD Modeler under Windows 8/7/Vista

In order to install CAD Modeler check the box "Install CAD Modeler?" on the form shown below during the GT STRUDL main installation procedure.

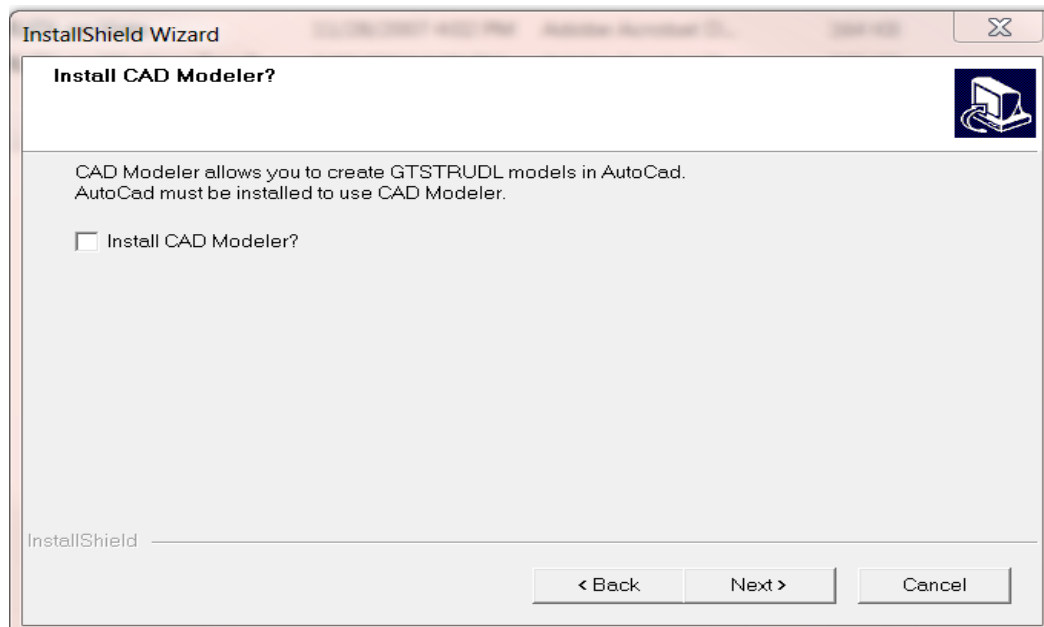

CAD Modeler Installation can also be launched independently, after GT STRUDL installation, by executing the file "CADM_setup.exe" which is located in the CADModeler folder in the GTStrudl

2015 installation directory. The following steps are common regardless if the installation was launched from the GT STRUDL main installation or independently.

The first screen is a welcome dialog that prompts you to close all other applications before continuing the installation. It is essential to close any running instances of GT STRUDL, CAD Modeler, or AutoCAD before continuing the installation.

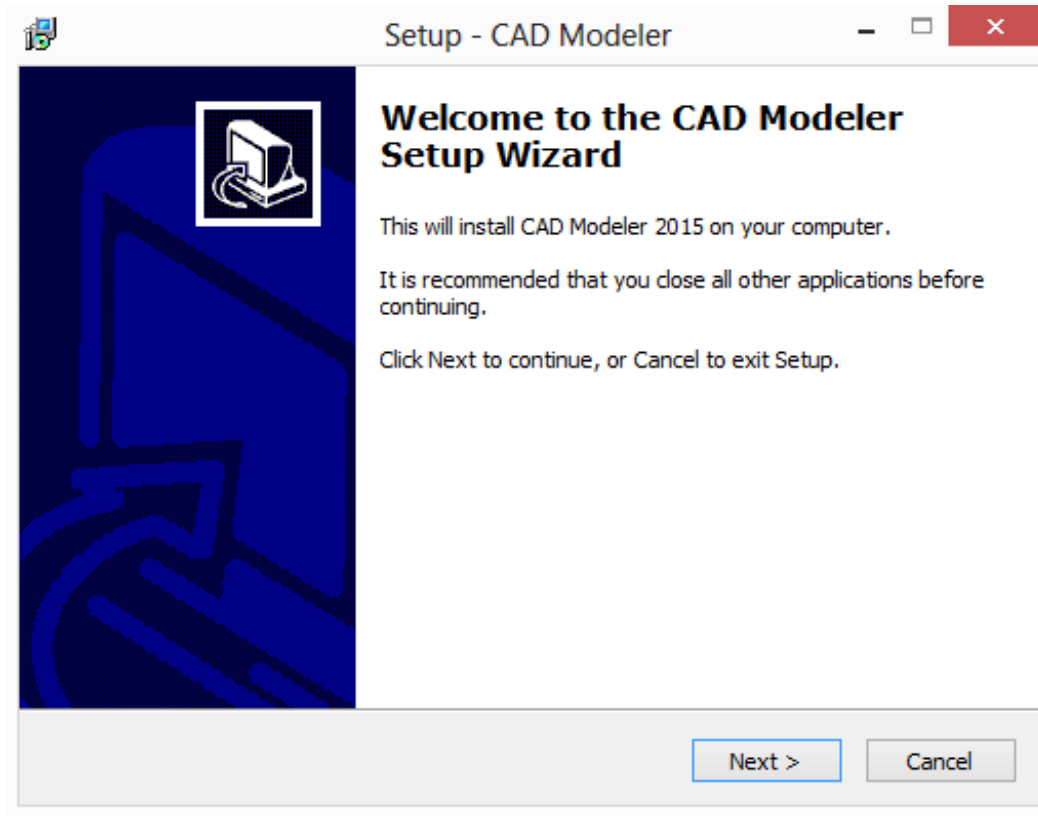

The next step is to select the components to be installed. The CAD Modeler Main Files are installed by default, and in addition you have to choose at least one version of the AutoCAD CAD Modeler Interface to be installed depending on the version of AutoCAD that is currently installed in your computer.

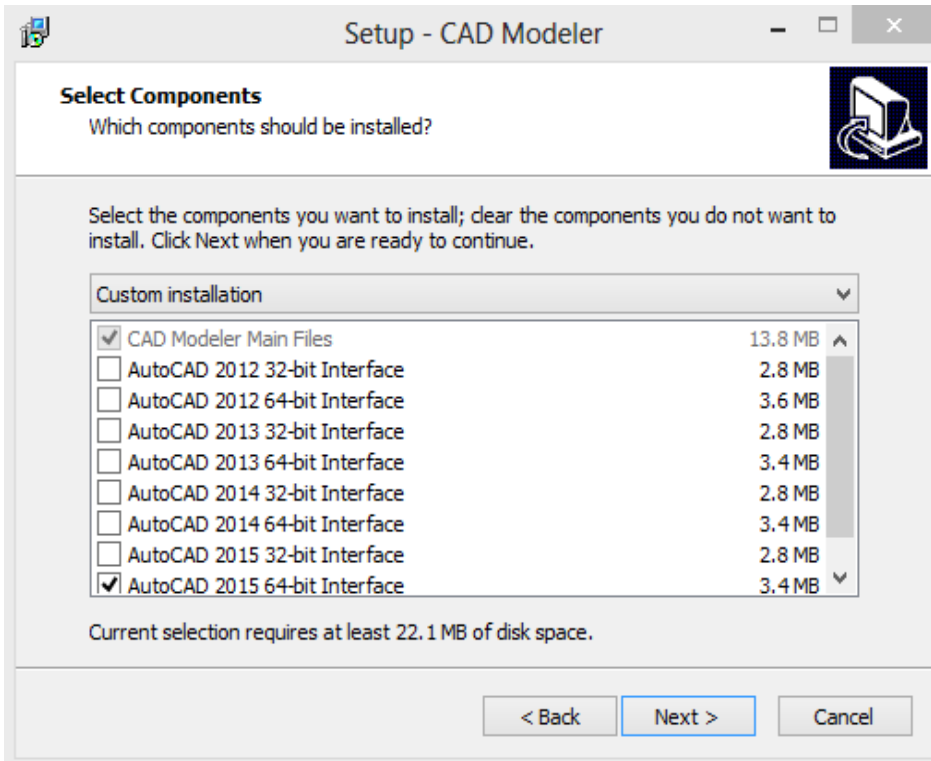

The last screen summarizes your selection and by pressing “Install” the installation procedure starts.

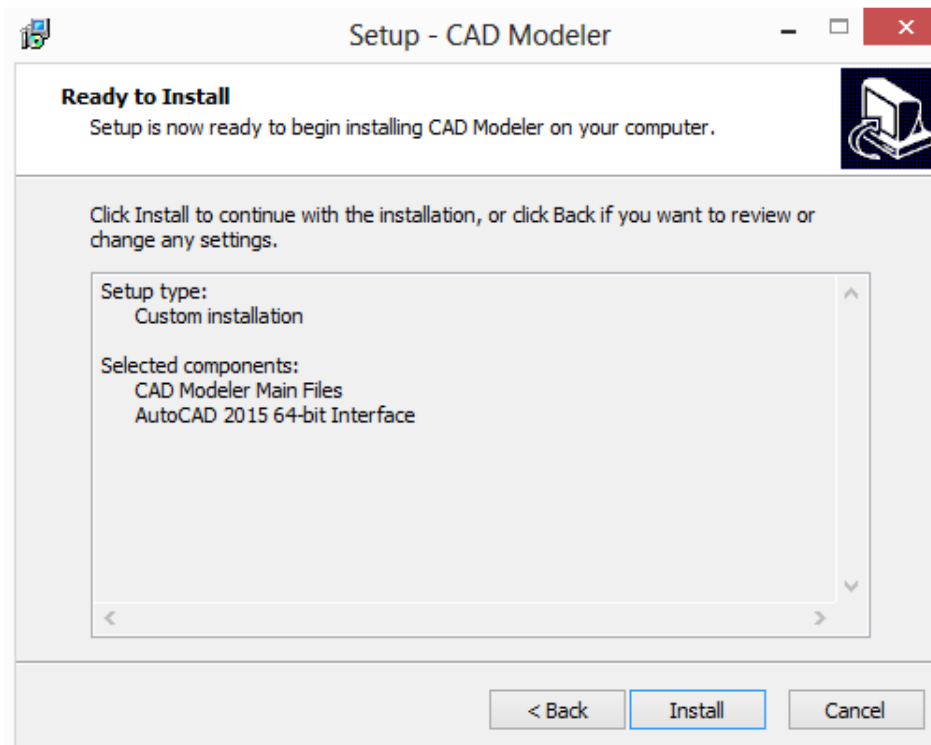

CAD Modeler is installed in the same installation directory with GT STRUDL, under the sub-directory “CADModeler”. For example, “c:\Program Files (x86)\GTStrudl\2015\CADModeler” is a typical CADModeler installation directory.

When the copy process is completed, a new dialog named “Finalizing Setup” appears and you are prompted to enter the corresponding AutoCAD Installation Directory.

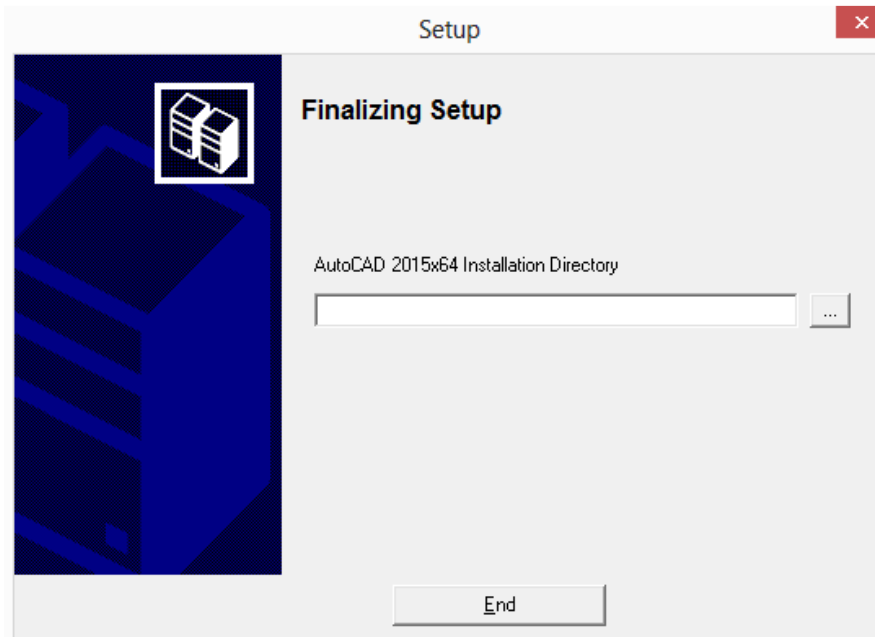

Press the browse “...” button to find and select the file “acad.exe”, in the AutoCAD installation directory, and press “Open”. The name of the directory is copied to the corresponding edit box, and by pressing “End”, the installation is complete.

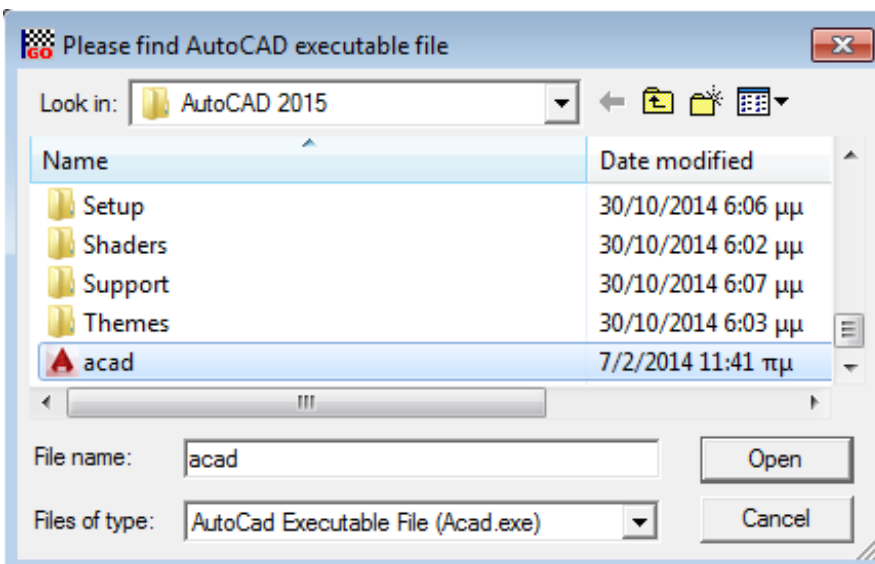

2. Using CAD Modeler

2.1. Overview of Using CAD Modeler and configuring AutoCAD

CAD Modeler can only be launched directly by GT STRUDL; by initializing an instance of AutoCAD and automatically loading CAD Modeler ARX Application (CADModeler.arx) in the same instance. CAD Modeler creates a separate AutoCAD user profile, named "CADModeler", so the CAD Modeler menus, icons and ribbons do not affect your standard AutoCAD environment, or other applications running on the top of AutoCAD.

CAD Modeler commands can be accessed from the menu, from the ribbon area, or by typing the specific command in the AutoCAD command prompt.

- If AutoCAD Menu is not turned ON, you have to type "MENUBAR" in AutoCAD's prompt, and then enter 1.
- If AutoCAD Ribbon is not turned ON, you have to type "RIBBON" in AutoCAD's prompt.

All GT STRUDL structural data, which are created using CAD Modeler, are stored in two files: the .dwg file which contains the AutoCAD information, and the .db file which contains the structural data. The two files have the same filename (only the extension is different) and they are linked together by CAD Modeler.

CAD Modeler creates a GT STRUDL Input File (.gti) and is able to send this .gti file to the main instance of GT STRUDL, which sits on the background. When analysis is performed in GT STRUDL and results are available for reading, CAD Modeler is able to load them from GT STRUDL DBX (data base exchange) files.

Since CAD Modeler is launched and licensed by the main GT STRUDL application you are not allowed to close the main GT STRUDL window. If GT STRUDL is closed, CAD Modeler outputs a warning and CAD Modeler commands are no longer functional.

2.2. Running CAD Modeler

CAD Modeler is launched from the GT STRUDL Welcome dialog by selecting the "CAD Modeler" icon. A new instance of AutoCAD, having CAD Modeler automatically loaded, is created. You will be able to identify that CAD Modeler is loaded successfully by having two additional menus ("GTS Modeling" and "GTS Display") next to the AutoCAD main menus and the "GTS CAD Modeler" tab in the ribbon area.

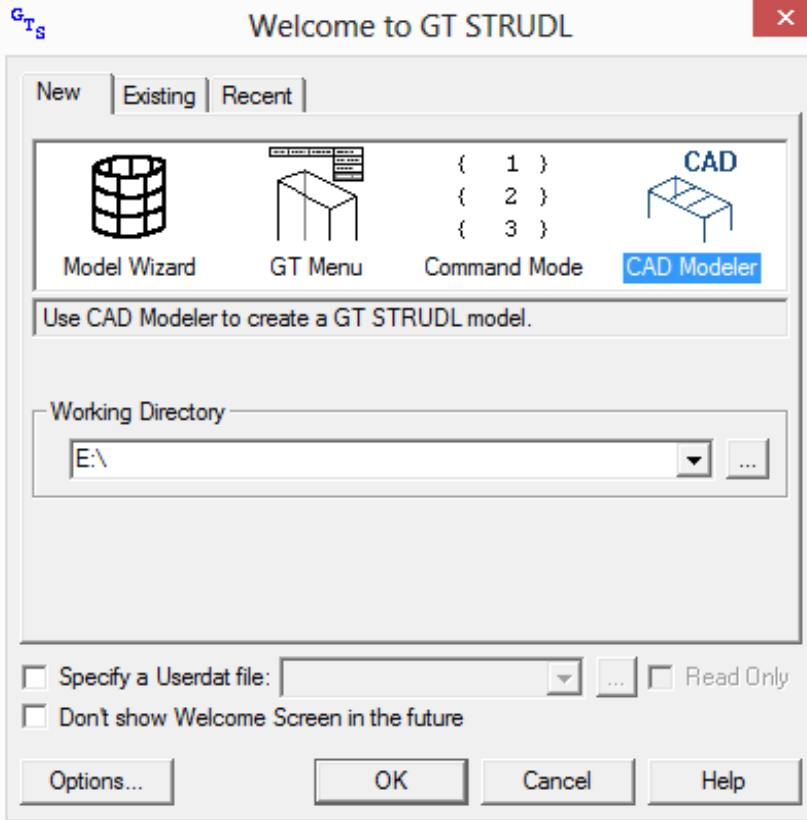

2.3. Menu Bar and Ribbon Area

CAD Modeler commands can be accessed from AutoCAD's Ribbon Area at the top of the window by selecting GTS Modeling or GTS Display:

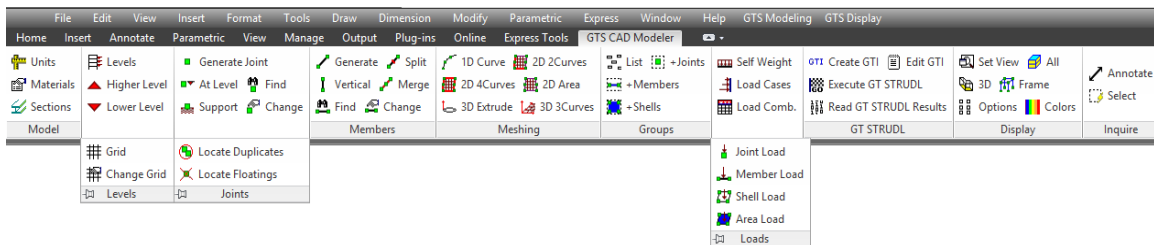

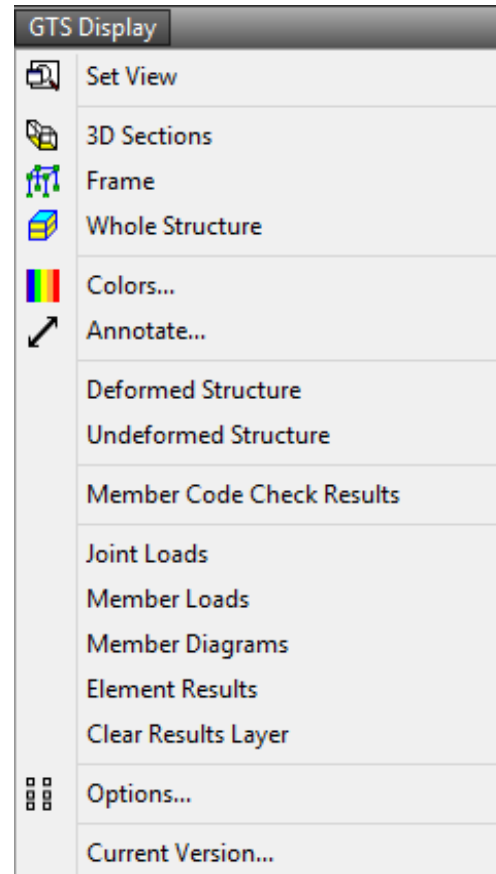
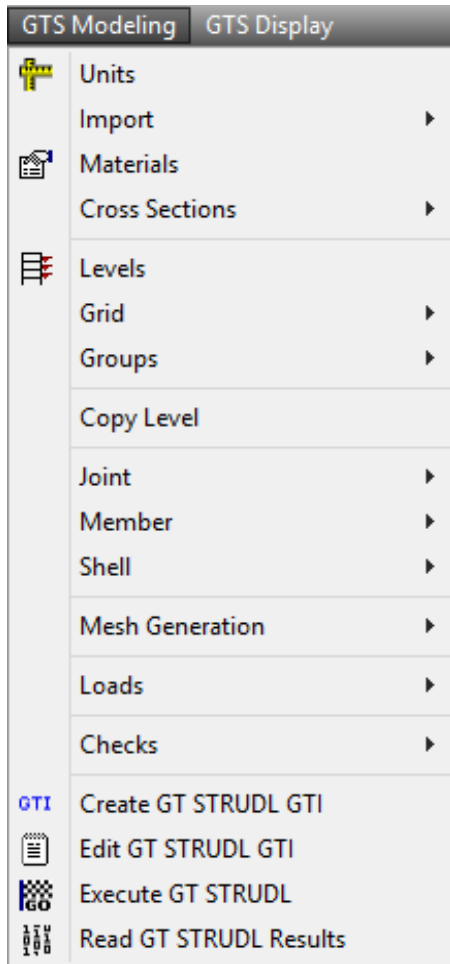

2.4. AutoCAD Commands

You can use AutoCAD commands, such as Move, Copy, Rotate, Mirror and Delete to generate your model faster. The assumptions made in the use of each command are:

- Move: By moving a joint, the members and finite elements connected to the joint “follow” this movement
- Copy: Joint, Member and Element Loads and Supports are not copied
- Mirror: Joint, Member and Element Loads and Supports are not copied or mirrored. The Beta Angle of members is not mirrored.
- Delete: If a joint is deleted, there is a prompt that asks for confirmation since members and elements connected to this joint will automatically be deleted as well.

2.5. CAD Modeler Commands

2.5.1. Units

The following form is used to define the active units, either from ribbon command  **Units** or from the menu “*GTS Modeling>Units*” or by typing `GTSUnits` at the command prompt.

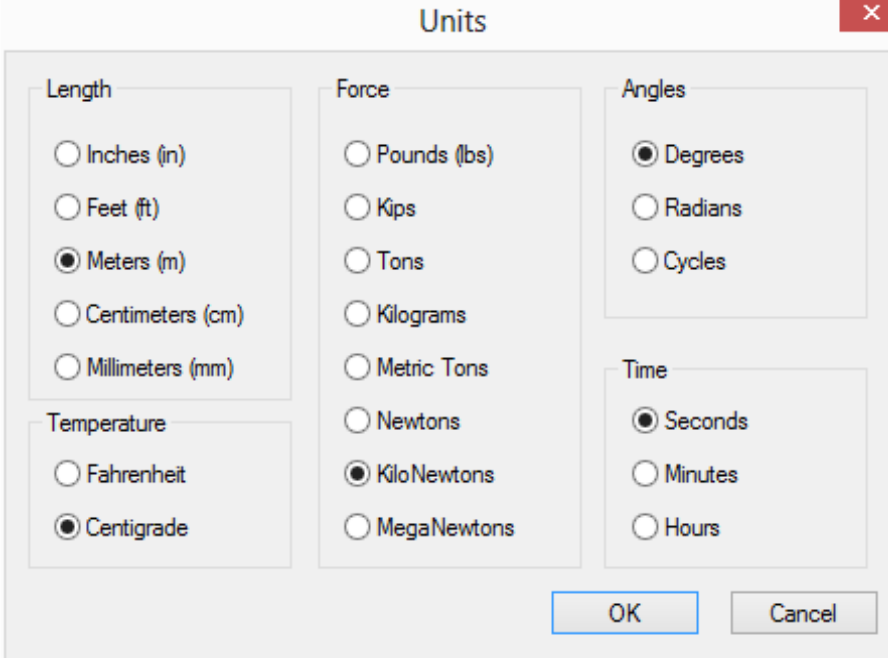

The screenshot shows the 'Units' dialog box with the following settings:

- Length:** Inches (in), Feet (ft), Meters (m), Centimeters (cm), Millimeters (mm)
- Force:** Pounds (lbs), Kips, Tons, Kilograms, Metric Tons, Newtons, KiloNewtons, MegaNewtons
- Angles:** Degrees, Radians, Cycles
- Time:** Seconds, Minutes, Hours

You can change the Units any time during working in CAD Modeler. The current units appear at the top of the main CAD Modeler window:

GTS CAD Modeler | M KN DEG FAH SEC | Drawing1.dwg

2.5.2. Materials

The following form is used to modify existing material properties or create new materials. You can select this command either from the ribbon command  **Materials** or from the menu “*GTS Modeling>Materials*” or by typing `GTSMaterials` at the command prompt.

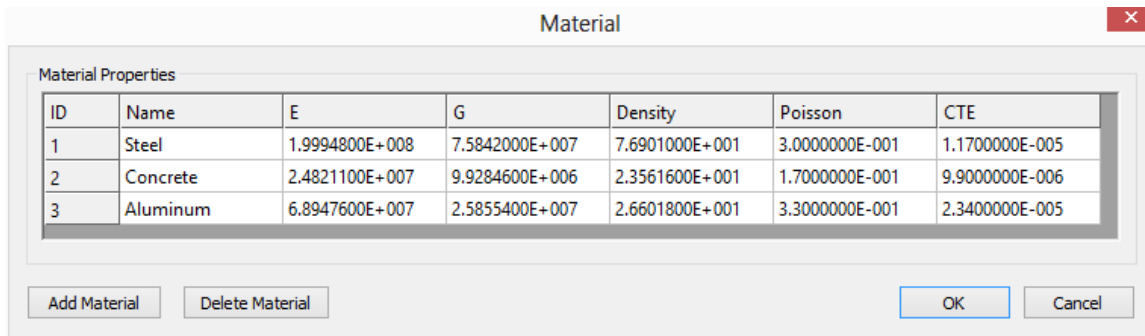



2.5.3. Sections

For models which contain frame members, you should select the cross sections to be added to your project either from the default cross section library or by creating user defined prismatic cross-sections.

Prismatic cross sections can be created from the Menu “GTS Modeling >Cross Sections>Prismatic” or by typing `GTSPismatic` at the command prompt.

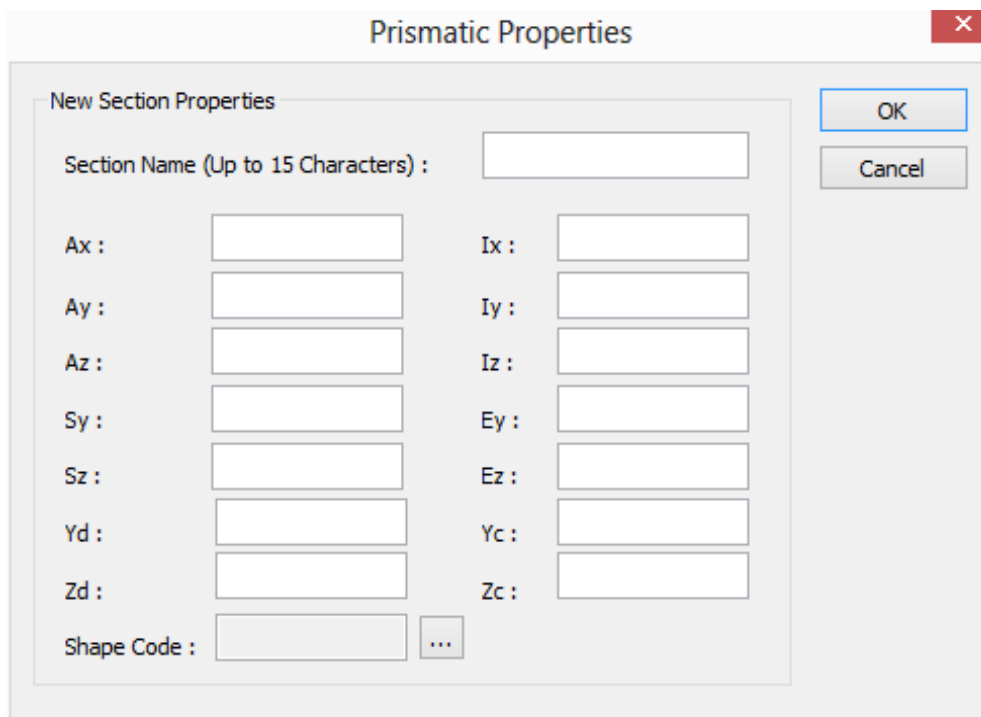
In the dialog shown below, you enter the cross sectional properties in the current unit system.



You can access the existing cross section library (GT STRUDL tables) from the ribbon command  Sections, or from the Menu “GTS Modeling>Cross Sections>Table” or by typing `GTSPParams` at the command prompt.

Using the following form, where all GT STRUDL built-in TABLES are available, you select the cross sections for your project by double clicking on them, at the right part of the screen. The list of

selected cross-section profiles appears at the left part of the screen and the selected profiles have a large black dot in front of them.

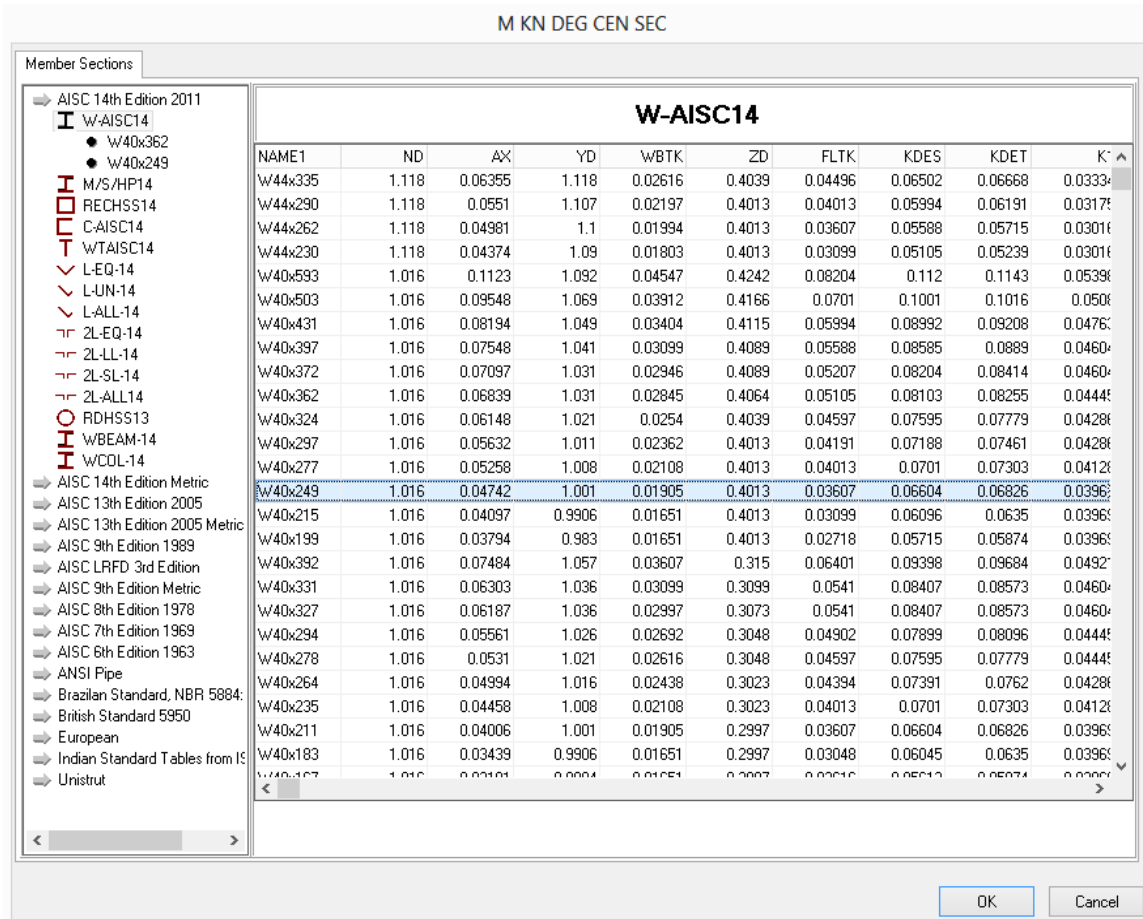

2.5.4. Levels

It is optional to define Levels (stories) in your structure. However, it is recommended that you do so when modeling industrial or other building-like structures as this will save you time during the creation of your model. You can access the level properties dialog from the ribbon icon  Levels or from the menu "GTS Modeling>Levels" or by typing GTSLevels at the command prompt.

Using the *Level Properties* form you can:

- Set the *Height* for each level, in current length units
- Define the visible status of each level: if *Visible* or not
- *Add Levels* to the model
- *Delete Levels* from the model
- *Detect Levels Automatically* using an algorithm to detect levels along the height of the structure by identifying locations having at least four horizontal members.
- *Merge Levels*, by selecting two or more levels and merging them to one.
- Define if the *Vertical Axis* is the global Z or global Y.
- *Update Levels for All Entities*, in order to assign the correct Level to each entity (joint, member or finite element) depending on its coordinates along the height of the structure.

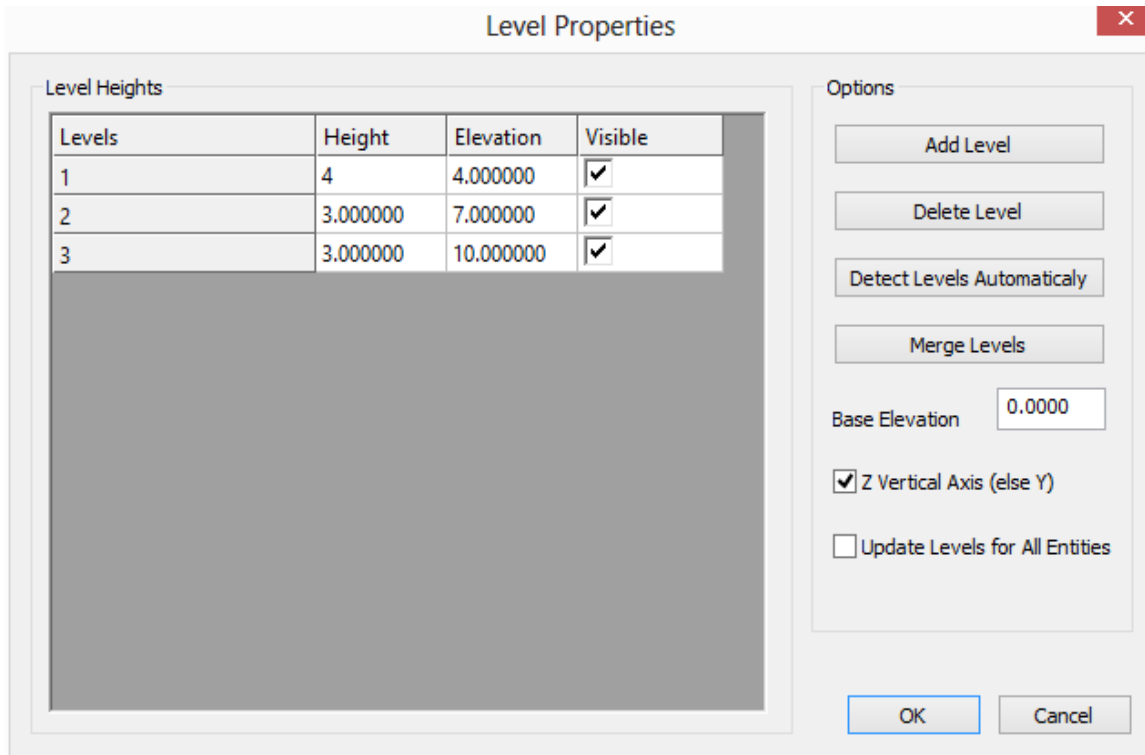

After defining Levels, you can switch between levels by either using the “Visible” checkboxes from the Level Properties form, or using the ▲ Higher Level and ▼ Lower Level icons in the ribbon area. You can also type `GTSLevelUp` and `GTSLevelDown` at the command prompt.

Moreover, you can define a grid system and/or generate vertical members (Columns) with a single click. These commands will be explained below.

Finally, the current level, if defined, appears at the top of CAD Modeler window, next to the Current Units.



2.5.5. Grid

A Grid system can be defined and used as a pattern for entering beams and columns. In order to be able to enter a Grid, you must first specify Levels in your structure (see the Levels command above). You can access the Grid dialog by expanding the “Levels” tab from the ribbon icon  Grid, or from the menu “GTS Modeling>Grid>Create” or by typing `GTSGrid` at the command prompt.

Grid ✕

Placement

Horizontal Sidelong

Spacing

5.0000

6.0000

7.0000

Distance:

Point Number

Angles

Grid Angle X-Axis :

Horizontal - Sidelong Angle :

Numbering

Text Height :

Numbers Distance :

Position

Left Right

Type

Numbers Letters

Start From :

Using the *Grid* form you can:

- Set different parameters for the *Horizontal* and *Sidelong* directions of the grid.
- Define and control the spacing in each direction, by entering the desired spacing – *Distance* of the new grid line and pressing *Add* button. Later on you can edit a specified spacing or delete it, using the corresponding buttons *Edit* and *Delete*.
- Define the *Angle* between the *Grid X-Axis* and the global X-axis
- The *Angle* between the *Horizontal* and *Sidelong* lines (default equal to 90 degrees)
- Control the *Height* of fonts
- Control the *Position* of the labels
- Control the *Type* of identification to be either Number or Letters
- Control the *Starting From* item, which can be a number or letter depending on the Type.

By pressing OK, you are prompted to enter the *Insert Point* of the grid, meaning the coordinates of the lower left corner of the grid. The grid lines are then created as shown in the figure on the next page.

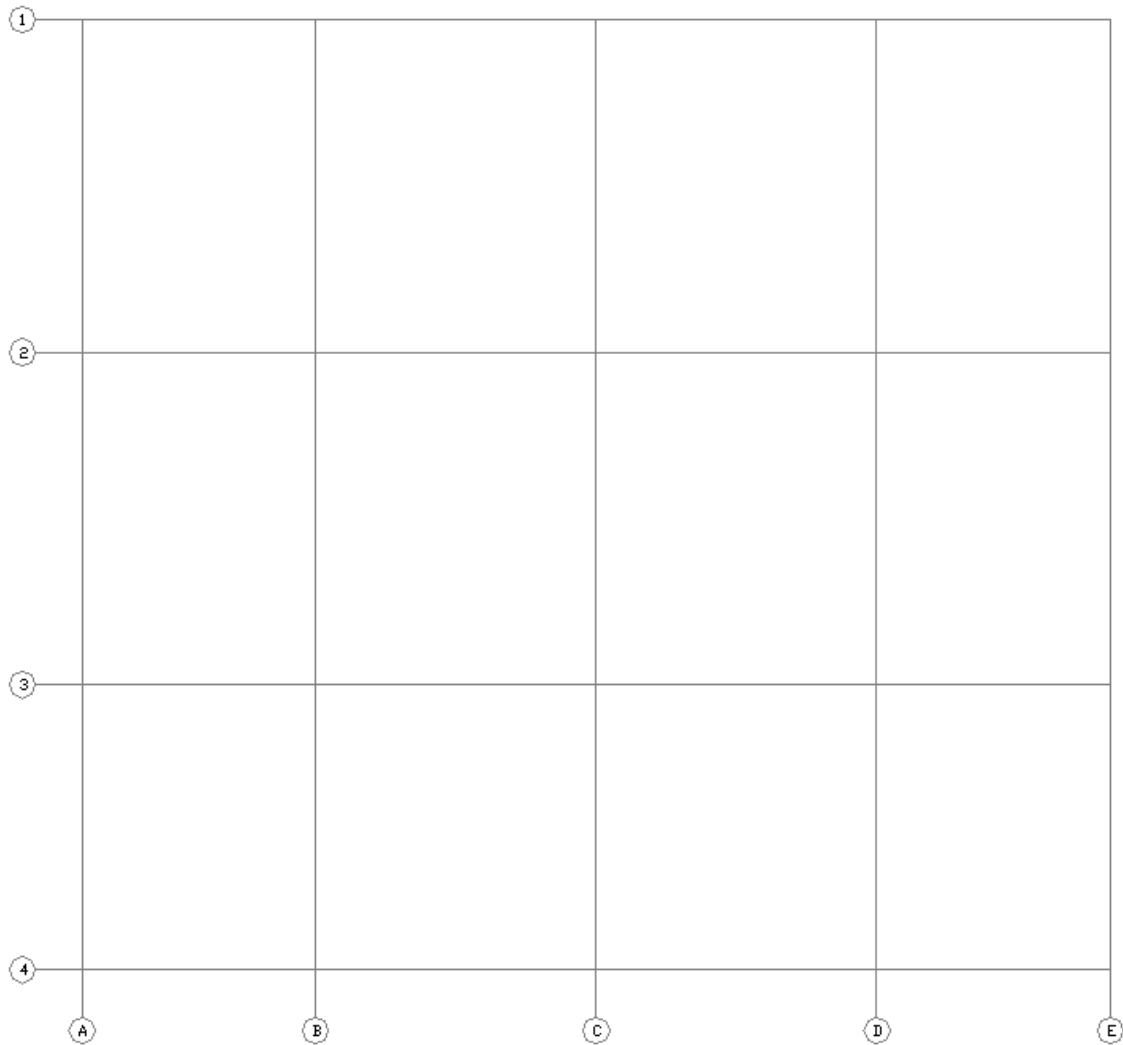

You can also change the properties of an existing grid by expanding the “Levels” tab and selecting the ribbon icon  **Change Grid**, or from the menu “GTS Modeling>Grid>Change” or by typing `GTSGridChange` at the command prompt, and then selecting the Grid to be edited.

2.5.6. Creating Joints

You can generate individual joints from the ribbon command  **Generate Joint** or from the menu “GTS Modeling>Joint>Generate Joint” or by typing `GTSJoint` at the command prompt. You then must enter the X,Y,Z coordinates (separated by comma) or click at the corresponding point at the screen. However, for frame structures, it is recommended to start generating members (and joints will be automatically generated at their ends).

If you have already defined Levels at the structure, you can generate individual joints at the current level from the ribbon command  **At Level** or from the menu “GTS Modeling>Joint>Generate Joint at Level” or by typing `GTSJointLevel` at the command prompt. You then have to enter only X and Y coordinate (Z will be calculated using the current Level’s Elevation)

2.5.7. Finding Joints

You can find an individual joint from the ribbon command  **Find** or from the menu “*GTS Modeling>Joint>Find*” or by typing `GTSFJID` at the command prompt and enter the name of the Joint. If the joint name exists, the joint will be selected (by clicking on “change”, you can modify it without making a new selection).

2.5.8. Joint Supports

You can find an individual joint from the ribbon command  **Support** or from the menu “*GTS Modeling>Joint>Support*” or by typing `GTSJointSupport` at the command prompt and select the joint or the joints to be supported. The Joint Properties form appears, where you can define which degrees of freedom are fixed and also enter a *spring* value in case of elastic supports. Using the *Quick Selection*, you can quickly define a Fixed, Pinned or Free Joint (by default all joints are free)

Restraints & Spring values

Quick Selection :

Restraint	Spring	Restraint	Spring
<input checked="" type="checkbox"/> Fx	<input type="text" value="0"/>	<input type="checkbox"/> Mx	<input type="text" value="0"/>
<input checked="" type="checkbox"/> Fy	<input type="text" value="0"/>	<input type="checkbox"/> My	<input type="text" value="0"/>
<input checked="" type="checkbox"/> Fz	<input type="text" value="0"/>	<input type="checkbox"/> Mz	<input type="text" value="0"/>

2.5.9. Joint Properties

You can change the properties of a joint from the ribbon command  **Change** or from the menu “*GTS Modeling>Joint>Change*” or by typing `GTSJointChange` at the command prompt and select the joint or the joints to be edited or by double-clicking on an existing joint.

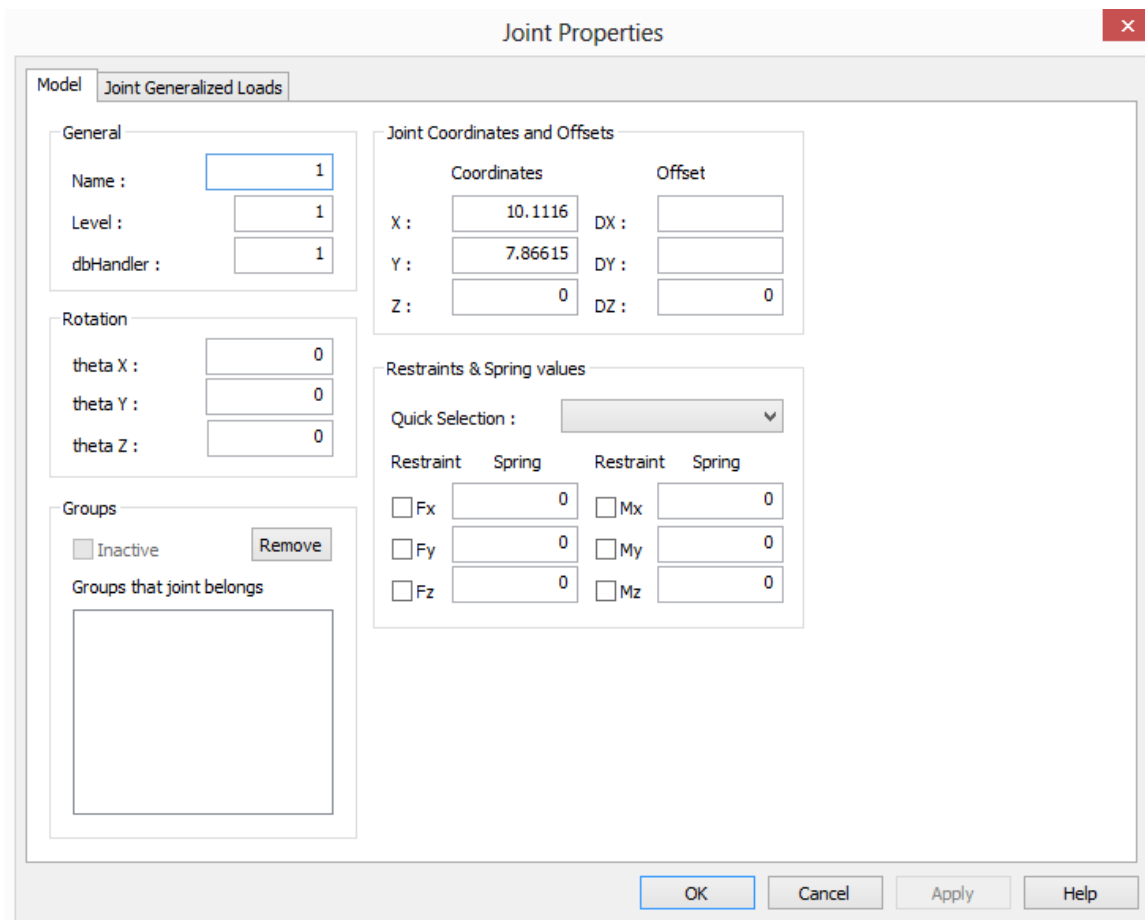

The “*Joint Properties*” form appears, and at the “*Model*” tab you can enter the *Name* of the Joint (up to 8 characters) the *Level* that the joint belongs (optional), the *theta rotation* angles for rotated support joints, the *Groups* that the joints belongs to, the *coordinates* of the joint in the current unit system, the restraints of the joint and the spring values.

If you select more than one joint, then “*Multiple Selection*” appears at the top of the Joint Properties form, and all data entered in the form will be applied to all selected joints.

2.5.10. Duplicate Joints

In order to erase joints that have the same coordinates (one on the top of the other) that may have been generated by mesh generation functions, you have to check the model for duplicate joints from the menu “*GTS Modeling>Checks>Check for Duplicate Joints*” or by typing `GTSCheckDuplicateJoints` at the command prompt. You then have to enter the desired merge accuracy (*Enter Merge Accuracy <0.001000>*). If duplicate joints exist in the structure, a new dialog appears having the full set of duplicate pairs, where you can select the joints to be merged or not as shown below.

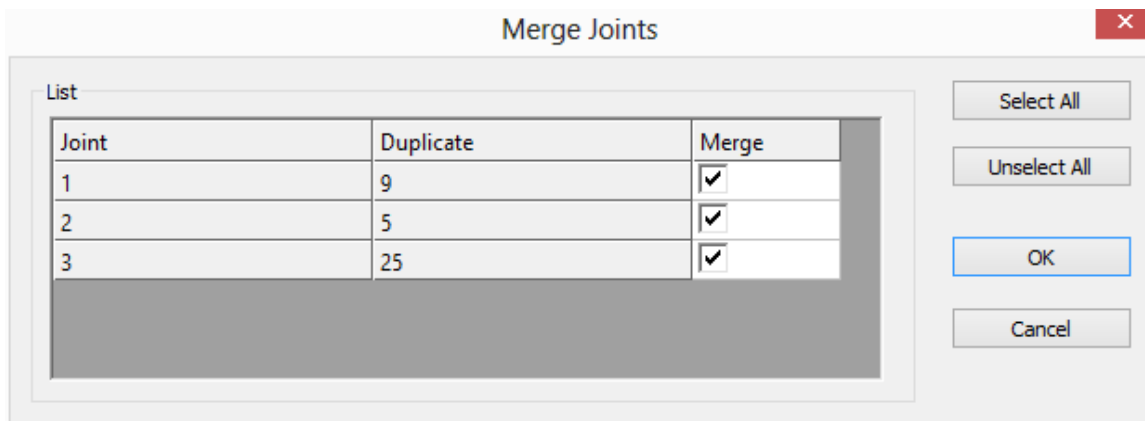

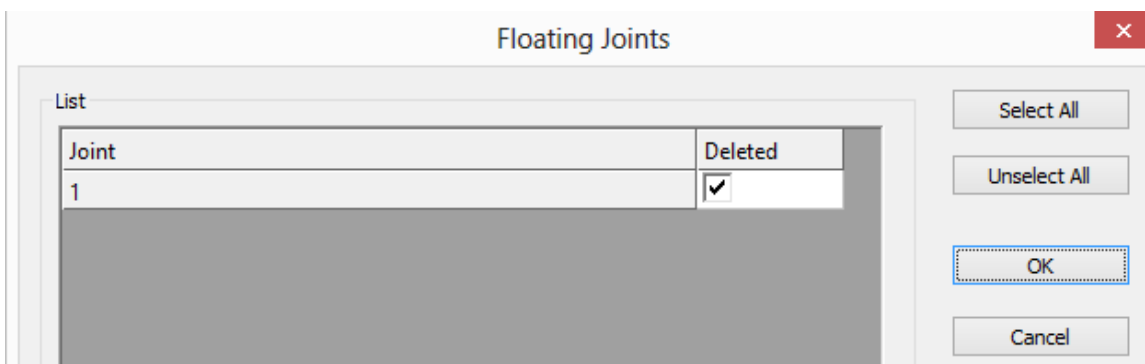

2.5.11. Floating Joints

Floating Joints are the joints that are not connected to any member or finite element, therefore they may cause instability in the solution of the mathematical model. Using the command “*GTS Modeling>Checks>Check for Floating Joints*” from the Menu or by typing `GTSCheckFloatingJoints` at the command prompt, floating joints are automatically identified, and using the corresponding form as shown below, they can be deleted.



2.5.12. Creating Members

You can generate individual members from the ribbon command  **Generate** or from the menu “*GTS Modeling>Members>Generate Beam Members*” or by typing `GTSBeam` at the command prompt. You must then enter the X,Y,Z coordinates (separated by commas or click at the corresponding point at the screen) of the member start and then of the member end. Joints are automatically generated at both member ends, unless a joint already exists at the specific point. If so, the member is connected to the existing joint(s).

If you have already defined Levels at the structure, you can generate vertical members (columns) at the current lever from the ribbon command  **Vertical** or from the menu “*GTS Modeling>Member>Generate Vertical Member*” or by typing `GTSColumn` at the command prompt. You then have to enter only one point (starting top point) in the floor plan. The ending

bottom point will be automatically calculated, having the same X and Y coordinates, and Z coordinate will be calculated by the current level's height.

2.5.13. Finding Members

You can find an individual member from the ribbon command  **Find** or from the menu “*GTS Modeling>Member>Find*” or by typing `GTSEFMID` at the command prompt and enter the name of the Member. If member name exists, the member will be selected (by clicking on “change” you can modify it without making a new selection).

2.5.14. Splitting Members

You can split a member into two or more parts from the ribbon command  **Split** or from the menu “*GTS Modeling>Member>Split Member*” or by typing `GTSSplitMember` at the command prompt and select the Member to be split. You then define “*Distance for splitting the member or the number of equal parts (negative number)*”, entering:

- the position of the split, meaning the length of the 1st part starting from starting joints, or
- the number of equal parts that will be generated after the split, by typing a negative number. For instance, entering -3 means to split the original member into 3 equal parts.

2.5.15. Merging Members

You can merge two members to one member from the ribbon command  **Merge** or from the menu “*GTS Modeling>Member>Merge Members*” or by typing `GTSMergeMembers` at the command prompt and select two members. The two members must have a common joint (middle). After merging the middle joint is NOT deleted and you have to delete it manually. This joint can be removed manually, using AutoCAD's erase command, or by using CAD Modeler's “Remove Floating Joints” Command.

2.5.16. Member Properties

You can change the properties of a member from the ribbon command  **Change** or from the menu “*GTS Modeling>Member>Change*” or by typing `GTSBeamChange` at the command prompt and select the member or the members to be edited or by double-clicking on an existing member.

The “*Member Properties*” form appears, and at the “*Model*” tab you can enter the *Name* of the Member (up to 8 characters), the *Level* that the member belongs to (optional), the *Type* of the Member (Space Frame or Space Truss), *Starting* and *Ending* Joints, *Beta Angle*, the *Groups* that the member belongs to, the *Cross-Section* applied to this member and the corresponding section properties, the *Material* of the member, member *releases* and *elastic end connection* spring values, *End Sizes* and global *Member Eccentricities*.

If you select more than one joint, then “*Multiple Selection*” appears at the top of the Member Properties form, and all data entered in the form will be applied to all selected members.

2.5.17. Creating Shell Finite Elements

Shell finite elements are generated automatically using the meshing functions described below. However, you can generate individual quadrilateral or triangle shell elements one by one.

Quadrilateral elements can be created from the menu “*GTS Modeling>Shell>Generate quad at joints*” or by typing `GTSShell` at the command prompt. You must then enter the X,Y,Z coordinates (separated by commas or click at the corresponding point at the screen) of the four corners of the quad element. Joints are automatically generated at both element ends, unless a joint already exists at the specific point. If so, the element is connected to the existing joint(s).

Triangular elements can be created from the menu “*GTS Modeling>Shell>Generate triangle at joints*” or by typing `GTSShellT` at the command prompt. You must then enter the X,Y,Z coordinates (separated by commas or click at the corresponding point at the screen) of the three corners of the triangular element.

2.5.18. Finding Shells

You can find an individual shell element from the menu “*GTS Modeling>Shell>Find*” or by typing `GTSFEID` at the command prompt and enter the name of the element. If the element name

exists, the shell element will be selected (by clicking on “change” you can modify it without making a new selection).

2.5.19. Shell Properties

You can change the properties of a shell finite element from the menu “GTS Modeling>Shell>Change” or by typing `GTSShellChange` at the command prompt and select the shell or the shells to be edited or by double-clicking on an existing shell element.

The “Element Properties” form appears as shown below, and from the “Model” tab, you can enter the *Name* of the Element (up to 8 characters), the *Level* that the element belongs to (optional), the *Type* of the Element, Joint *Incidences*, the *Thickness* of the shell, the *Groups* that the element belongs to and the *Material* of the element.

If you select more than one element, then “Multiple Selection” appears at the top of the Element Properties form, and all data entered in the form will be applied to all selected elements.

2.5.20. Meshing along a curve

You can create several members along any selected AutoCAD linear entity, that can be a Line, an Arc or a Circle, from the ribbon command  **1D Curve** or from the menu “GTS Modeling>Mesh Generation>1D Along Line or Curve or Circle” or by typing `GTSMesh1D` at the command prompt.

After selecting the AutoCAD linear entity the Mesh Properties dialog appears, where you can define:

- The *Material* of the members to be generated.
- The *Type* of the members (FRAME or TRUSS)
- The *Cross-Section* of the members from a list of previously selected project sections.
- The *Beta* angle that defines the orientation of the cross-section in 3D space.
- The number of members, to be generated, that can be equally spaced (*uniform*) or may have *variable* spacing.
- The *Labeling* (optional) of the joints and members to be generated (“*Enter Labeling Rules*” form), where you can set the First ID for joints and members and their labeling prefix.
- By clicking “*Preview*” you are able to preview the members to be generated (without creating any entities).
- By clicking “*Create*” the members are generated and the *Mesh Properties* form is closed.

By selecting Variable spacing, the “*U1-Curve Spacing*” form appears, where you can enter the *Total Number of Spaces*, and the *Length* of each part, either in absolute distance or as a percentage of the line or curve’s total length using the dialog shown on the next page.

U1-Curve Spacing ✖

Current Totals

Total # of spaces :	0	Curve Length :	1847.094685
Current # Spaces :	0	Current Length :	0.000000
Remaining # Spaces :	0	Remaining Length :	1847.094685

Variable Spacing

# Spaces	Distance	or Percent

The “Enter Labeling Rules” form allows you to set the First ID for joints and members to be created and their labeling prefix. Note that the total length of the label cannot be more than 8 characters.

Enter Labeling Rules

Properties

Joints Prefix	
First Joint's ID	1
Elements Prefix	
First Element's ID	1
Members Prefix	
First Member's ID	1

2.5.21. Meshing between two lines

You can create Members or Finite Elements between two selected AutoCAD linear entities such as Lines or Arcs, from the ribbon command  **2D 2Curves** or from the menu “GTS Modeling>Mesh Generation>2D Between 2 Lines or Curves” or by typing `GTSMesh2D2L` at the command prompt. You are then asked to select two AutoCAD curves that will define the U and V boundaries of the Mesh.

The dialog has the same options as in the 1D mesh command and in addition you can also define:

- Members or Elements to be generated (for Members the options are the same as in 1D)
- *Type* of Finite Elements, from the available GT STRUDL Finite Element library
- *Thickness* of Finite Elements

- Spacing in both the U and V directions

2.5.22. Meshing between four lines

You can create Members OR Finite Elements between four selected AutoCAD linear entities, that can be Lines or Arcs, from the ribbon command  **2D 4Curves** or from the menu “*GTS Modeling>Mesh Generation>2D Between 4 Lines or Curves*” or by typing `GTSMesh2D4L` at the command prompt. You are then asked to select four AutoCAD curves that will define the U1, U2, V1 and V2 boundaries of the Mesh as shown in the figure below with U2 opposite U1 and V2 opposite V1

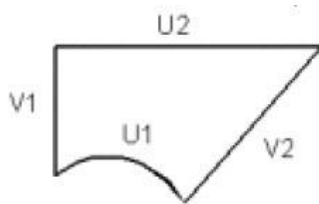

The dialog has the same options as in the 2D mesh between two curves command.

2.5.23. Meshing inside a polyline

You can create Finite Elements inside an AutoCAD closed curve, that can be a Polyline or a Circle, from the ribbon command  **2D Area** or from the menu “*GTS Modeling>Mesh Generation>Inside Polyline*” or by typing `GTSMesh2DPoly` at the command prompt. You are then prompted to select the closed AutoCAD polyline or circular curve.

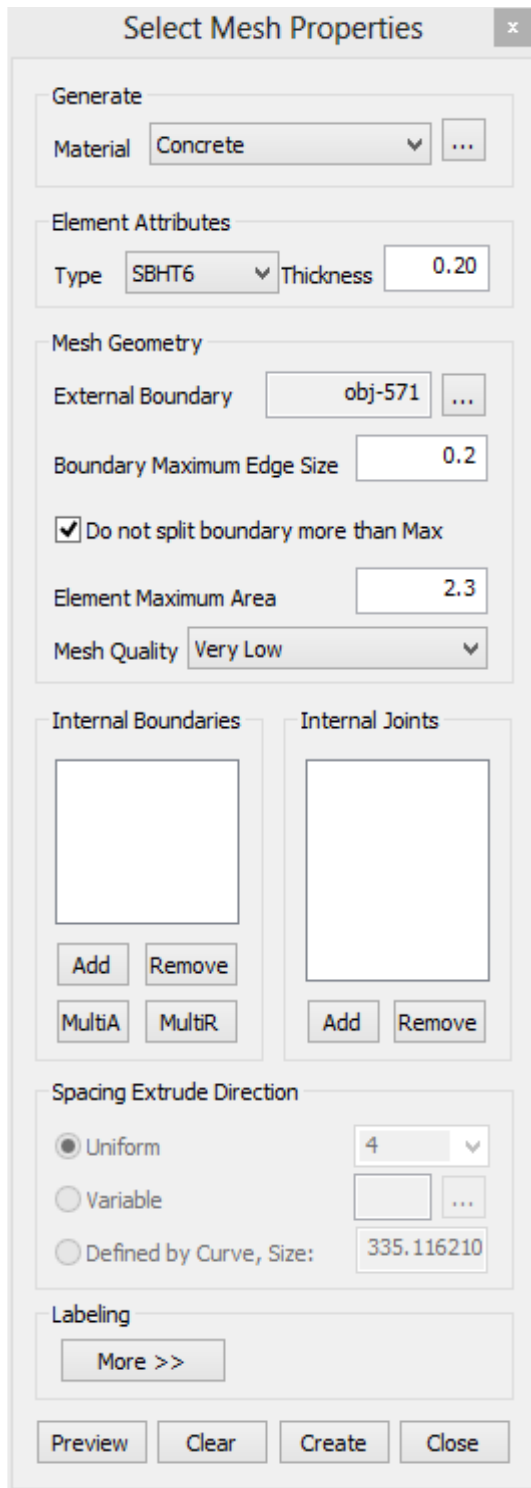

After selecting the AutoCAD entity the *Mesh Properties* dialog appears, where you define:

- The *Material* of the elements to be generated
- *Type* of Finite Elements from the available GT STRUDL Finite Element library
- *Thickness* of Finite Elements
- The *Maximum Edge Size* along the Boundary. CAD Modeler will generate additional joints along the boundaries so that there is no finite element edge, along the boundary curve, longer than the entered value.
- You can have the boundary curve to be split in smaller parts than the Max, or not. Additional splitting may be required if you try to increase the quality of the finite element mesh or if you try to control the maximum area of the finite elements.
- The maximum area of each finite element.
- The quality of the triangles that are going to be generated.
- Add one or multiple (MultiA) internal closed boundaries (polylines or circles), or open boundaries (arcs or lines). If a closed internal boundary is selected there is a question asking if you want the elements inside the boundary to be removed (treat it as a hole) or not. Moreover, you will be asked a question regarding the size of elements along the internal boundary curve, that can be 0, so as to follow the current value of the "*Boundary Maximum Edge Size*", or it can be a positive number which defines the maximum length along the internal boundary, or it can be a negative integer which defines the number of equal parts that the internal boundary will be split.

- Add internal joints (points) that will be additional corners of the finite element mesh.
- Labeling, Preview and Create functions are identical to the ones of the previously described meshing forms.

2.5.24. Meshing by extruding a polyline

You can create Finite Elements by extruding an AutoCAD closed curve, that can be a Polyline or a Circle, from the ribbon command  **3D Extrude** or from the menu “GTS Modeling>Mesh Generation>3D Extrude PolyLine” or by typing `GTSExtrudePoly` at the command prompt. You are then prompted to select AutoCAD curves, first the extruded curve, and then the curve which defines the extrude direction which can be either a line or polyline. The finite elements will be generated on the extruded surface.

The “Mesh Properties” form is similar to the “Meshing inside a polyline” properties form but you must also define the “Spacing Extrude Direction”, meaning the parameters that control the size of elements along the extrude direction. *Uniform* and *Variable* options are suitable if the extrude entity is a line. “Defined by Curve, size” is suitable if the extrude entity is a polyline, so that it is enforced that joints will be generated at the intermediate points of the polyline.

Labeling, Preview and Create functions are identical to the ones of the previously described meshing forms.

2.5.25. Meshing using 3 curves

You can create Members OR Finite Elements between three selected AutoCAD linear entities, that can be Lines or Arcs, from the ribbon command  **3D 3Curves** or from the menu “GTS Modeling>Mesh Generation>3D Between 3 Lines or Curves” or by typing `GTSMesh3D3L` at the command prompt. You are then asked to select three AutoCAD curves that will define the U, V and W boundaries of the Mesh.

The dialog has the same options as in the 2D mesh command, between 2 lines, with the extra parameters for the meshing in the W direction.

2.5.26. Groups

It is optional to define Groups in your model, but it is strongly advised to do so, since it will be easier to control the display and modeling of parts of your structure. Each Group is defined as a set of joints, members and finite elements. Each structural entity can belong in more than one group. Moreover, Groups defined in CAD Modeler are exported to the GT STRUDL Input file (.gti), meaning you can also use them in GT STRUDL analysis and design commands.

You have to first define the name of each group from the ribbon icon  **List** or from the menu “GTS Modeling>Groups>Manage” or by typing `GTSGroups` at the command prompt.

Using the Groups Form you can:

- Set the *Name* of each Group
- *Add Groups* to the model
- *Delete Groups* from the model
- Define if this Group is corresponding in a “*Physical*” member definition (used in Steel Design commands).

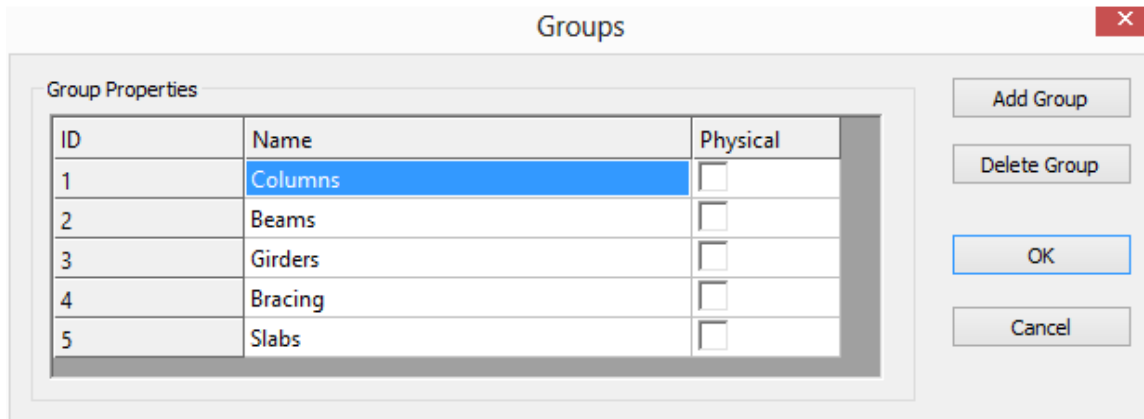



The screenshot shows a dialog box titled "Groups" with a close button (X) in the top right corner. Inside the dialog, there is a section labeled "Group Properties" containing a table with three columns: "ID", "Name", and "Physical". The table has five rows of data. The first row is highlighted in blue. To the right of the table are four buttons: "Add Group", "Delete Group", "OK", and "Cancel".

ID	Name	Physical
1	Columns	<input type="checkbox"/>
2	Beams	<input type="checkbox"/>
3	Girders	<input type="checkbox"/>
4	Bracing	<input type="checkbox"/>
5	Slabs	<input type="checkbox"/>

After defining a group you can enter joints, members and shell elements to it using the commands:

 **+Joints** ribbon icon, or “*GTS Modeling>Groups>Add Joints*” or by typing `GTSGroupJoints` at the command prompt

 **+Members** ribbon icon, or “*GTS Modeling>Groups>Add Members*” or by typing `GTSGroupMembers` at the command prompt

 **+Shells** ribbon icon, or “*GTS Modeling>Groups>Add Shells*” or by typing `GTSGroupShells` at the command prompt

2.5.27. Self - Weight

The Self-weight load of the structure can be created from the ribbon command  **Self Weight** or from the menu “*GTS Modeling>Loads>Self Weight*” or by typing `GTSSelfWeight` at the command prompt.

Self Weight or Dead Loads ✖

Load Information

Name :

Description :

Loads applied parallel to this Global Axis

Negative Y Positive Y
 Negative Z Positive Z
 Negative X Positive X

Factor : Include Finite Elements

The “Self-Weight” form appears where you can define the global direction of the self-weight and a factor (default = 1.0) for the self-weight and also define if the self-weight of finite elements will be taken into account or not.

2.5.28. Load Cases

A new load case can be created from the ribbon command  **Load Cases** or from the menu “GTS Modeling>Loads>Load Cases” or by typing `GTSNewLoadCase` at the command prompt. The “Load Case” form appears as shown below where you can enter new load cases, modify existing ones, or delete them.

Load Case ✕

Load Case Information

Load ID (up to 8 chars) : Create New

Description : Save / Modify

Load ID List :

LL
 PL

Delete

Exit

2.5.29. Joint Loads

A Joint Load can be entered from the ribbon command  **Joint Load** or from the menu “*GTS Modeling>Loads>Joint Load*” or by typing `GTSJointLoad` at the command prompt. You then have to select the joint or the joints that the load will be applied to.

At the “*Joint Generalized Loads*” tab you can apply joint loads or displacements. On the left part of the form, you can see a list of all available load cases: Load cases having loads already applied to the specific joint appear at the top list box. Load cases that do not have any loads applied to the specific joint appear at the bottom list box. Next to the name of each load case there is a \$ symbol followed by the total number of joints that are already loaded in the specific load case.

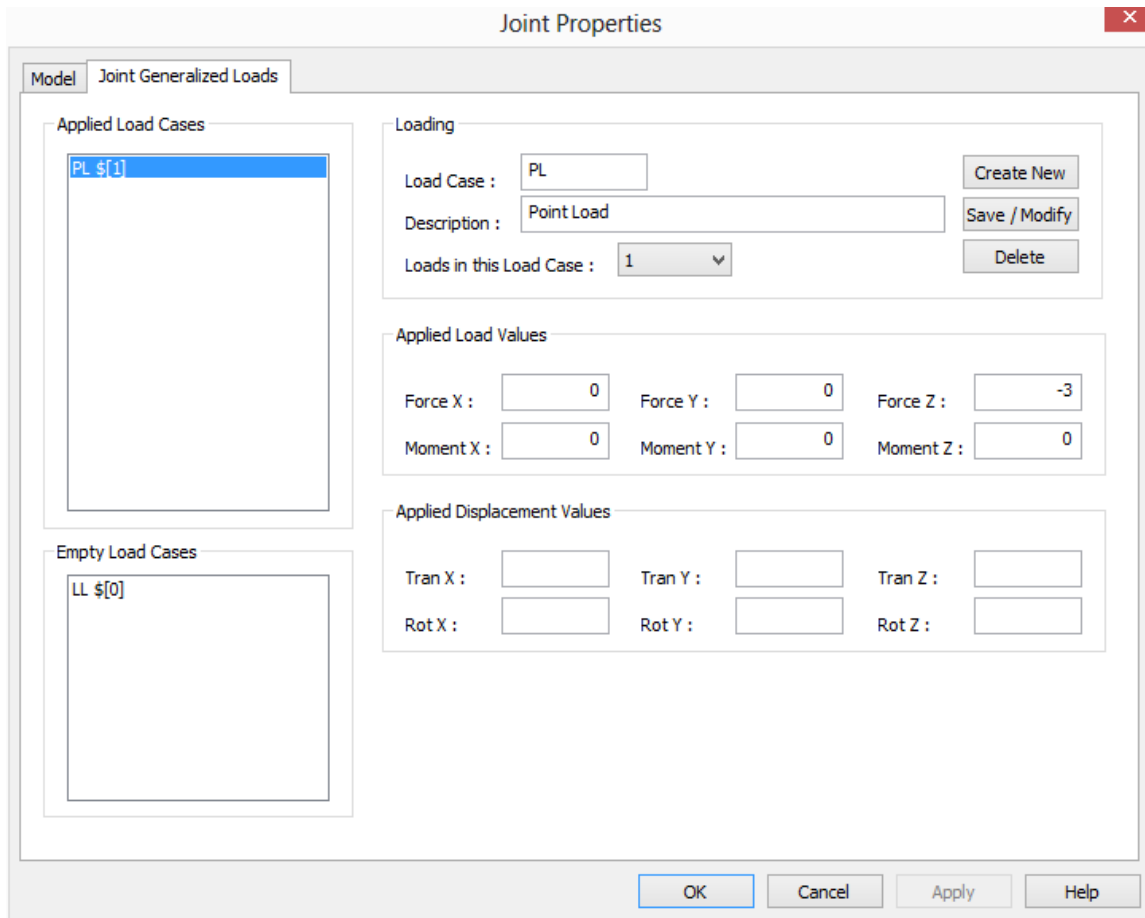

2.5.30. Member Loads

A Member Load can be entered from the ribbon command  **Member Load** or from the menu “GTS Modeling>Loads>Member Load” or by typing `GTSBeamLoad` at the command prompt. You then have to select the member or the members that the load will be applied to.

At the “Member Loads” tab or the Member Properties form as shown below, you can apply member loads. In the left part of the form you can see a list of all available load cases: Load cases having loads already applied to the specific member appear in the top list box. Load cases that do not have any loads applied to the specific member appear in the bottom list box. Next to the name of each load case there is a \$ symbol followed by the total number of members that are already loaded in the specific load case. The load distribution can be Concentrated, Uniform, Linear or Triangular and it can be applied in any local member or global direction. The Location can be entered in fractional terms (0: start, 1: end) or absolute terms in current length units measured from the start of the member.

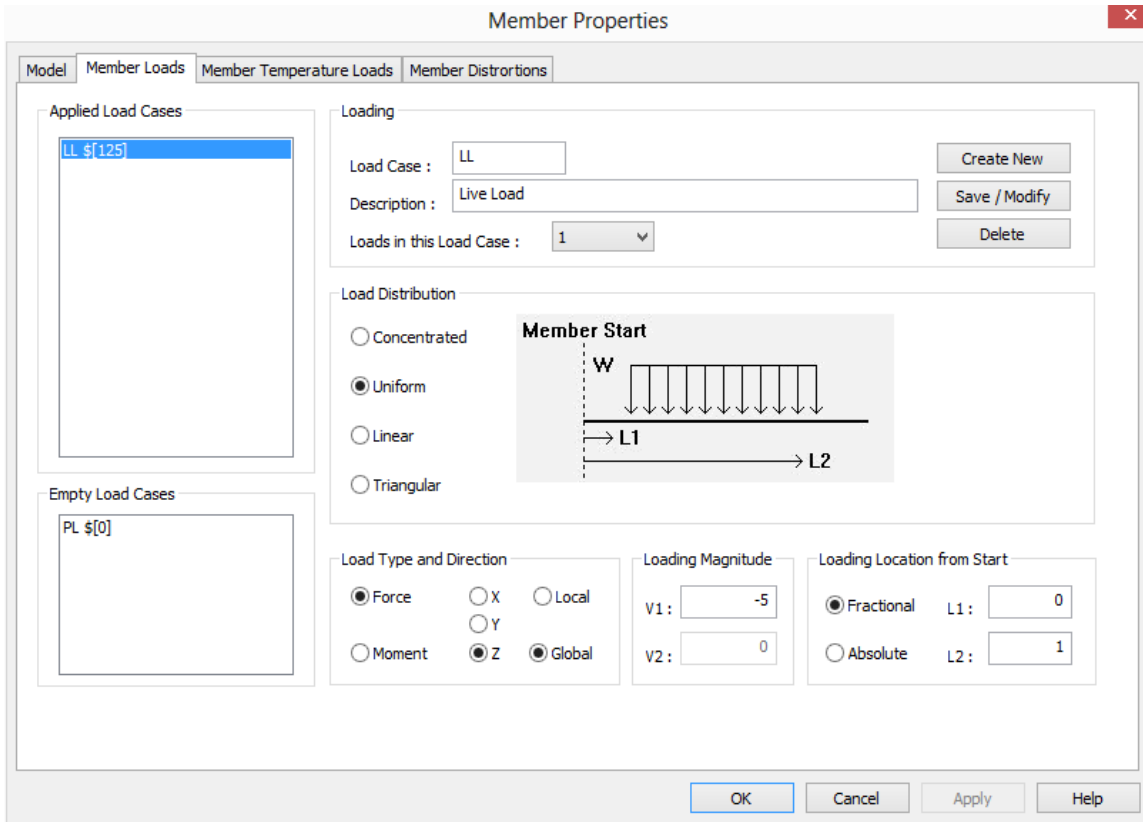

Using the “*Member Temperature Loads*” tab, you can define Axial or Bending temperature change along a part of the member, similar to the “*Member Loads*” tab as shown on the next page

Finally, using the “*Member Distortions*” tab, you can define concentrated or uniform distortion of the member in any direction along the member as shown on the next page.

Member Properties ✖

Model
Member Loads
Member Temperature Loads
Member Distortions

Applied Load Cases

Loading

Load Case :

Description :

Loads in this Load Case :

Temperature Change

X Axial Uniform through cross-section

Y Bending Vary through depth Change :

Z Bending Vary through width

Location: Length experiencing temperature change

Fractional (% 0-1) Starting Location :

Absolute (len) Ending Location :

Empty Load Cases

LL \$[0]

PL \$[0]

Member Properties ✖

Model
Member Loads
Member Temperature Loads
Member Distortions

Applied Load Cases

Loading

Load Case :

Description :

Loads in this Load Case :

Distortion Type

Concentrated

Uniform

Distortion Direction - Value

Displacement X

Rotation Y Value :

 Z

Distortion Location

Fractional (% 0-1) LA :

Absolute (Len) LB :

Empty Load Cases

LL \$[0]

PL \$[0]

2.5.31. Shell Loads

A Shell Load can be entered from the ribbon command  **Shell Load** or from the menu “*GTS Modeling>Loads>Shell Load*” or by typing `GTSShellLoad` at the command prompt. You then have to select the shell or the shells that the load will be applied to.

Using the “*Element Loads*” tab of the Element Properties form, you can apply element loads. In the left part of the form, you can see a list of all available load cases: Load cases having loads already applied to the specific element appear in the top list box. Load cases that do not have any loads applied to the specific element appear in the bottom list box. Next to the name of each load case there is a \$ symbol followed by the total number of elements that are already loaded in the specific load case. The Force type can be Body, Surface or Edge, in any Local, Planar, Global or Projected direction with uniform or variable values.

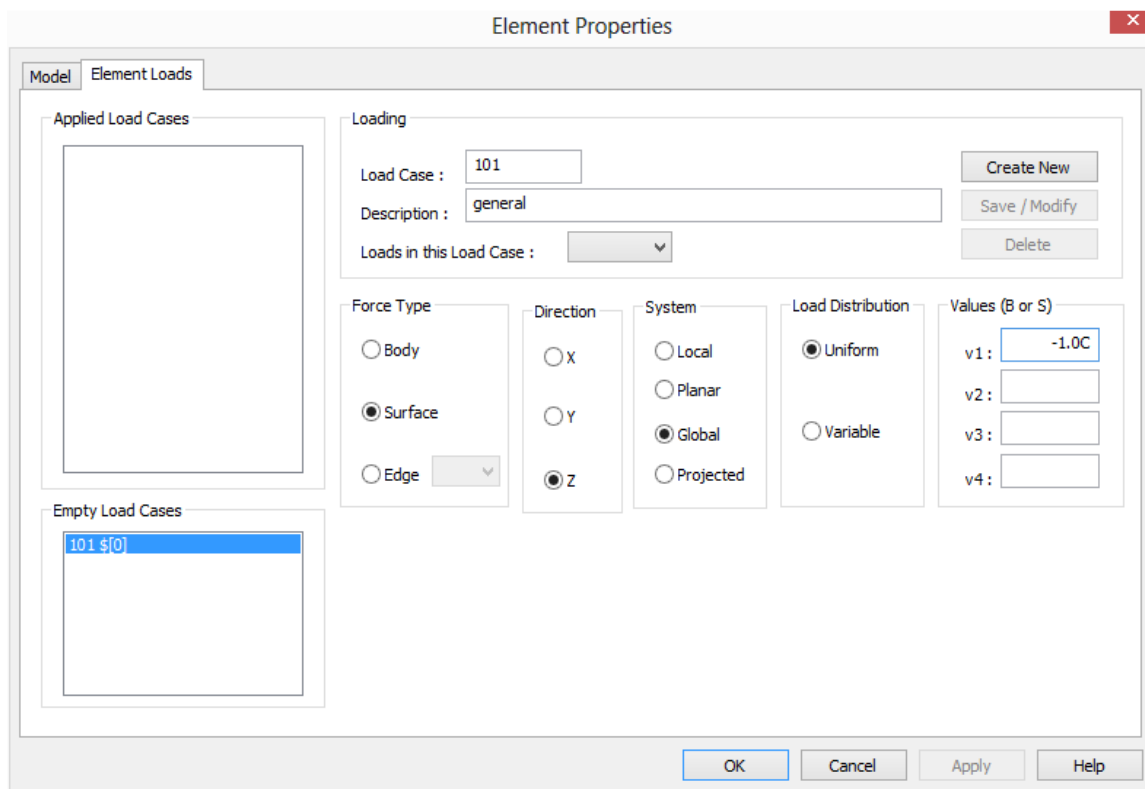

The screenshot shows the "Element Properties" dialog box with the "Element Loads" tab selected. The "Loading" section includes a "Load Case" field with the value "101", a "Description" field with the value "general", and a "Loads in this Load Case" dropdown menu. There are buttons for "Create New", "Save / Modify", and "Delete". The "Force Type" section has radio buttons for "Body", "Surface" (selected), and "Edge", with a dropdown menu next to "Edge". The "Direction" section has radio buttons for "X", "Y", and "Z" (selected). The "System" section has radio buttons for "Local", "Planar", "Global" (selected), and "Projected". The "Load Distribution" section has radio buttons for "Uniform" (selected) and "Variable". The "Values (B or S)" section has input fields for "v1" (value: -1.0C), "v2", "v3", and "v4". The "Applied Load Cases" list is empty, and the "Empty Load Cases" list contains one entry: "101 \$[0]". At the bottom, there are buttons for "OK", "Cancel", "Apply", and "Help".

2.5.32. Area Load

Area Load can be entered from the ribbon command  **Area Load** or from the menu “*GTS Modeling>Loads>Area Load*” or by typing `GTSAreaLoad` at the command prompt.

Area Load x

Generate

Name : Create New

Description : Save / Modify

Delete

Direction

Global Direction Perpendicular to the Loading Plane :

X Y Z

Plane Tolerance :

Elevation

Plane Perpendicular at :

Value (coordinate)

Joint

Distribution

Two way X

One way Y

Custom X Y

Load

Load Value :

Exit

Using the Area Load form you can define:

- The Name of the Load (up to 8 characters)
- The description of the load
- The Global direction of the loading plane (X, Y or Z) and the tolerance
- The position of the plane, defined by a coordinate or an existing Joint
- The distribution of the load (one way or two way)
- The Loading Value in current units.

2.5.33. Load Combinations

A new load combination can be created from the ribbon command  **Load Comb.** or from the menu “GTS Modeling>Loads>Load Combinations” or by typing `GTSLoadCombination` at the command prompt. The “New Load Combination” form appears where you can enter new load combinations. For each Load Case or Load Combination, that appears in the left list box, you define a factor and using the “ADD>>” button the selected load case is added in the combination.

When all load cases are added, press the “STORE” button to store the load combination.

Using the same form, you can also Edit an Existing Load Combination (remember to press “STORE” after you are done with the modifications) and also Delete an Existing Load Combination.

New Form Load or Load Combination ✖

Load Information

Name :

Description :

Type

Load Combination

Form Load

Combine

SW (Self Weight)
LL (Live Load)
PL (Point Load)
CB1 (Load Combination 1) 'SW' 1.35000 'LL' 1.50000 'PL' 1.50000

ADD >>

Factor :

SW 1.35000
LL 1.50000
PL 1.50000

Delete Item

STORE V

All Formed Loads or Combinations

CB1 (Load Combination 1) 'SW' 1.35000 'LL' 1.50000 'PL' 1.50000

Edit
Delete

Done

2.5.34. Create GTI

A GT STRUDL Text Input file can be generated from the ribbon command **GTI Create GTI** or from the menu *"GTS Modeling>Create GT.STRUDL GTI"* or by typing `GTSExportGTI` at the command prompt. In the *"Create GTSTRUDL Input File"* dialog, you can enter the filename of the GTI File and add additional commands to your GTI file, such as the Stiffness Analysis command to perform a static analysis automatically and commands which control the analysis results data that can be imported into CAD Modeler immediately after the analysis is complete.

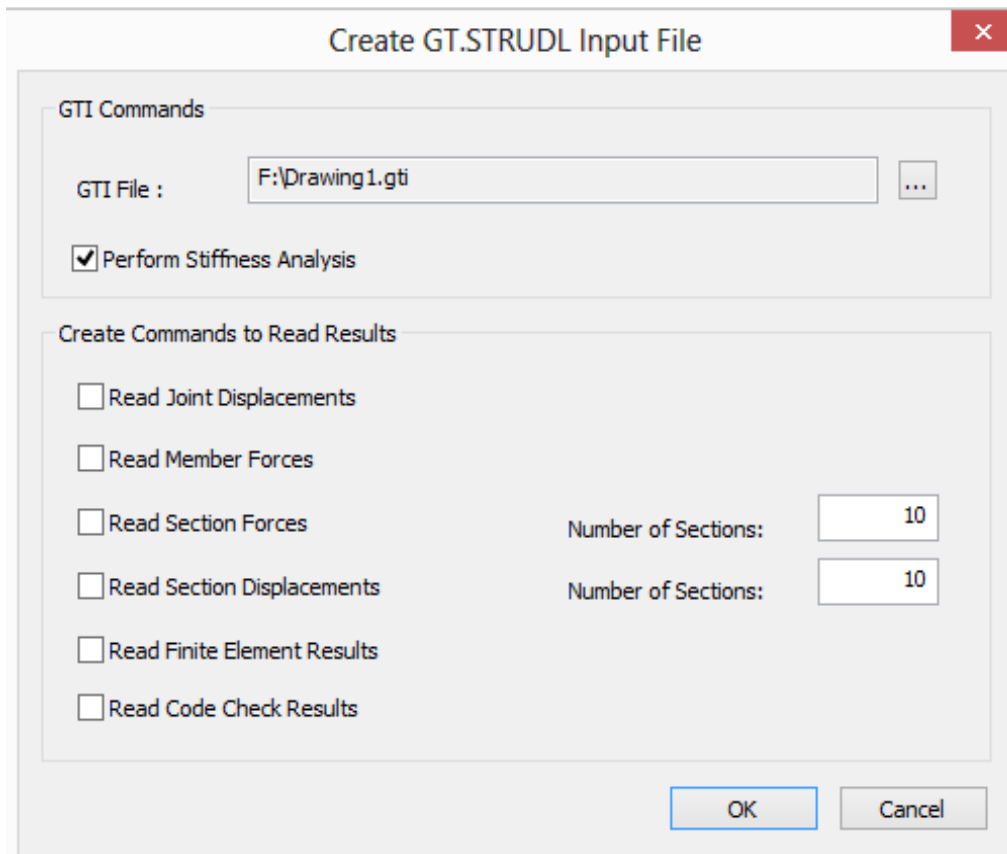

2.5.35. Edit GTI

The GT STRUDL Text Input file can be edited from the ribbon command  **Edit GTI** or from the menu “*GTS Modeling>Edit GT.STRUDL GTI*” or by typing `GTSEditGTI` at the command prompt. The previously created GTI is opened for editing using the default text editor.

2.5.36. Execute GT STRUDL URDL

GTSTRUDL can be launched, to process the previously created GTI, from the ribbon command  **Execute GT STRUDL** or from the menu “*GTS Modeling>Edit GT.STRUDL GTI*” or by typing `GTSExecuteGTI` at the command prompt.

2.5.37. Read Analysis Results

After performing the stiffness analysis in GT STRUDL, results can be read back to CAD Modeler, from the ribbon command  **Read GT STRUDL Results** or from the menu “*GTS Modeling>Read GTSTRUDL Results*” or by typing `GTSResultsGTI` at the command prompt.

“Read GTSTRUDL Results” form appears, where you can choose to import Displacements, Member Forces, Section Forces, Section Displacements and Finite Element Results. Depending on your selection a set of GTI DBX commands are created in the edit boxes shown below. If you have selected the same options in “Generate GTI” command, then the DBX commands are already included in your GTI file. Else, they should be copied and pasted into GT STRUDL main window. Do not press OK before the writing of the files in the GT STRUDL main window has completed.

Read GT.STRUDL Results

Read DBX Results

GTI Directory : E: ...

Read Joint Displacements

Read Member Forces

Read Section Forces Number of Sections: 10

Read Section Displacements Number of Sections: 10

Read Finite Element Results

Type of element result : Stresses

Surface : <ALL>

Read Code Check Results

GTI Commands

After running the analysis, ENTER the following commands in GT.STRUDL command line:

```
DBX BINARY
WRITE REPLACE JOINT RESULTS JOINTS EXISTING
WRITE REPLACE MEMBER RESULTS MEMBERS EXISTING
WRITE REPLACE SECTION FORCES NS 10 MEMBERS EXISTING
WRITE REPLACE SECTION DISPLACEMENTS GLOBAL NS 10 MEMBERS EXISTING
WRITE REPLACE CODE MEMBERS EXISTING
```

WAIT for files to be CREATED and THEN press OK

OK Cancel

By pressing OK you will get the confirmation message “Results Loaded Successfully” at the command prompt. Else, you will get an error message informing you about the type of analysis results that are missing and the corresponding DBX full path file names.

2.5.38. Import GTI

An existing GTI file can be imported it into CAD Modeler from the menu “GTS Modeling>Import>GT.STRUDL GTI” or by typing `GTSGTIRead` at the command prompt. Note that the GTI should be generated by the command “File>Save>Text Input File...” from GT STRUDL main menu.

2.5.39. Set Views

You can switch between different 2D or 3D views of the structure from the ribbon command  **Set View** or from the menu “GTS Display>Set View” or by typing `GTSSetView` at the command prompt.

It is strongly recommended to use Z as the vertical axis, so as to be able to use all built-in AutoCAD functions for Views (Top, Bottom, Left, Right, Isometric, etc). However, if you use Y as the vertical axis, you can use this form to have identical 2D and 3D views, as in GTMenu.

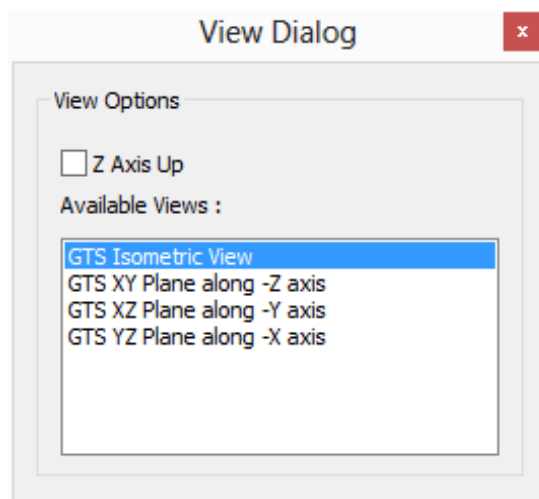

2.5.40. 3D or Wireframe View of the Structure

You can switch between the 3D view or wireframe view of the structure.

You can view the 3D display of your model from the ribbon command  **3D** or from the menu “GTS Display>3D Sections” or by typing `GTSset3D` at the command prompt. When 3D view is selected, all members appear as solid cross sections and shell elements are displayed in 3D view taking into account their thickness.

You can view the wireframe display of your model from the ribbon command  **Frame** or from the menu “*GTS Display>Frame*” or by typing `GTSSet1D` at the command prompt. When the wireframe view is selected, all members and shell edges are displayed as lines.

If some parts of the structure are hidden (i.e. using Level’s form) you can display the whole structure from the ribbon command  **All** or from the menu “*GTS Display>Whole Structure*” or by typing `GTSSetAllVisible` at the command prompt.

2.5.41. Colors and Visible Elements

You can control the color of each member or element, and its visibility from the ribbon command  **Colors** or from the menu “*GTS Display>Colors*” or by typing `GTSColorView` at the command prompt.

Using the tab “*Sections*” in the “*Color Options*” form shown below, you can assign a different color for each cross-section profile and set its visibility to ON or OFF. By pressing “*Reset Colors*”, all colors are set to defaults.

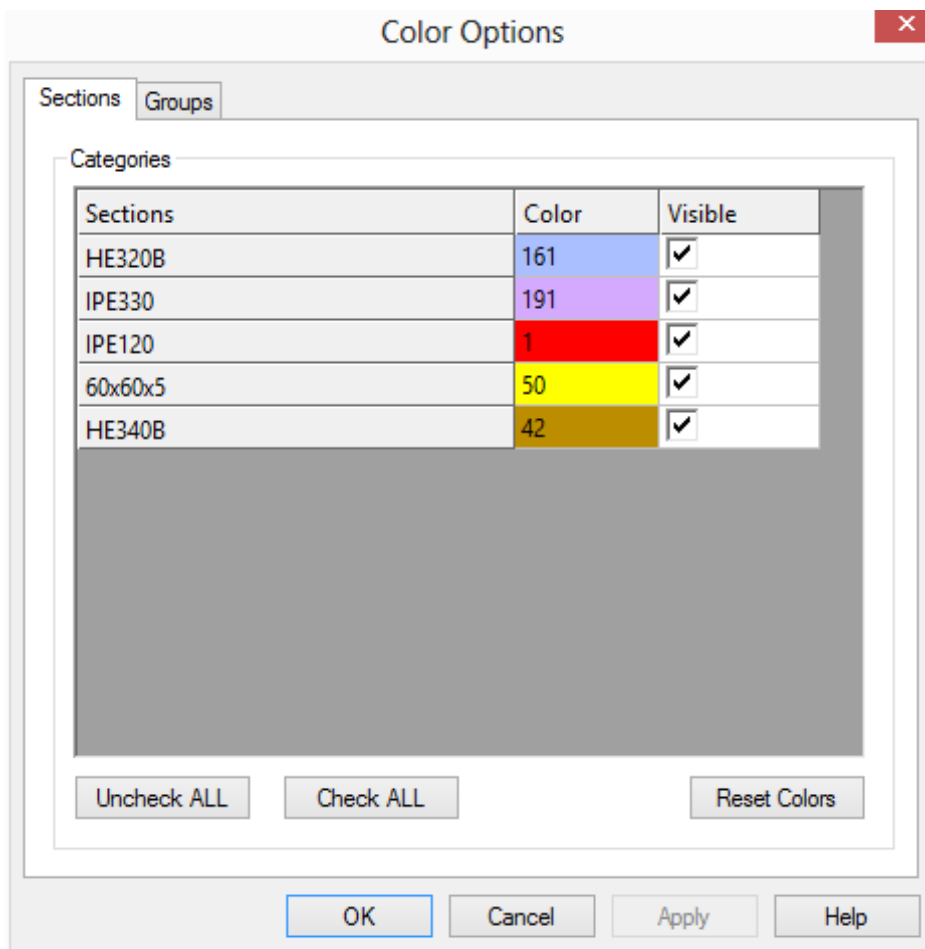

The image shows a dialog box titled "Color Options" with a close button (X) in the top right corner. It has two tabs: "Sections" (selected) and "Groups". Under the "Sections" tab, there is a "Categories" section containing a table with three columns: "Sections", "Color", and "Visible". The table lists five sections with their corresponding colors and visibility checkboxes. Below the table are three buttons: "Uncheck ALL", "Check ALL", and "Reset Colors". At the bottom of the dialog are four buttons: "OK", "Cancel", "Apply", and "Help".

Sections	Color	Visible
HE320B	161	<input checked="" type="checkbox"/>
IPE330	191	<input checked="" type="checkbox"/>
IPE120	1	<input checked="" type="checkbox"/>
60x60x5	50	<input checked="" type="checkbox"/>
HE340B	42	<input checked="" type="checkbox"/>

Using the tab “Groups” in the “Color Options” form, you can assign a different color for each group and set its visibility to ON or OFF. Moreover, you can set a color for entities that do not belong to any group (*UnGrouped data*). For entities belonging to more than one group, only the 1st group is taken into account.

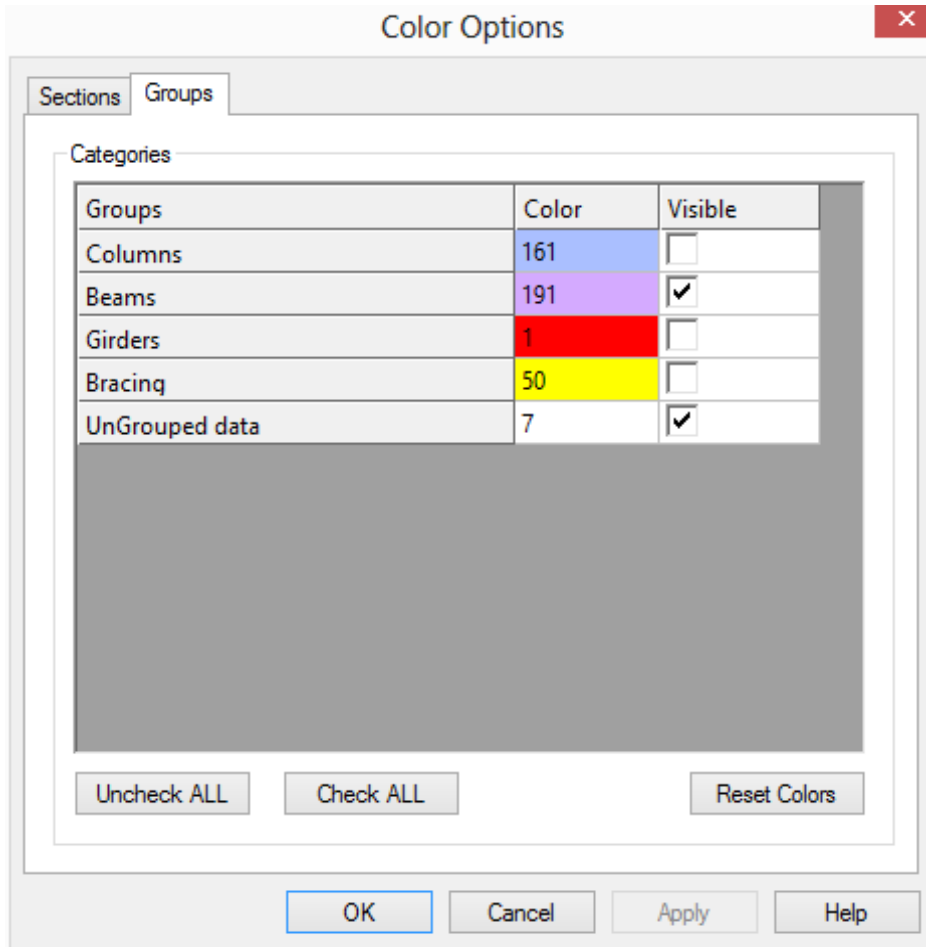

Note, that if the “Sections” tab is active when pressing “OK”, then the colors will be selected according to the “Sections” tab. If the “Groups” tab is active when pressing “OK”, then the colors will be selected according to the “Groups” tab.

2.5.42. Display Options

You can set the display options from the ribbon command  **Options** or from the menu “GTS Display>Options” or by typing `GTSDisplay` at the command prompt. Using the “Display Options” form shown below, you can set which objects will be visible or not, set their colors and which labels will be visible or not. You can also define font sizes for labels and object sizes.

Display Options ✕

<p>Visible Objects</p> <p><input checked="" type="checkbox"/> Joints </p> <p><input checked="" type="checkbox"/> Members </p> <p><input checked="" type="checkbox"/> 2D Elements </p> <p><input checked="" type="checkbox"/> 3D Elements </p>	<p>Visible Labels</p> <p><input type="checkbox"/> Joints </p> <p><input type="checkbox"/> Members </p> <p><input type="checkbox"/> 2D Elements </p> <p><input checked="" type="checkbox"/> 3D Elements </p>
<p>Label Settings - Font Sizes</p> <p>Joints : <input style="width: 50px;" type="text" value="0.250000"/></p> <p>Members : <input style="width: 50px;" type="text" value="0.250000"/></p> <p>2D Elements : <input style="width: 50px;" type="text" value="0.250000"/></p> <p>3D Elements : <input style="width: 50px;" type="text" value="0.250000"/></p> <p>Annotation : <input style="width: 50px;" type="text" value="0.250000"/></p> <p>Load Values : <input style="width: 50px;" type="text"/> <input style="width: 50px;" type="text" value="0.250000"/></p>	<p>Object Sizes</p> <p>Joint : <input style="width: 50px;" type="text" value="0.050000"/></p> <p>Load Arrowhead : <input style="width: 50px;" type="text" value="0.150000"/></p>
<p>Scale Factors</p> <p>Concentrated Load : <input style="width: 50px;" type="text" value="0.100000"/></p> <p>Distributed Load : <input style="width: 50px;" type="text" value="0.100000"/></p>	
<p><input type="button" value="OK"/> <input type="button" value="Cancel"/></p>	

2.5.43. Annotate

You can display information related to your model from the ribbon command  **Annotate** or by typing `GTSAnnotate` at the command prompt. The “Annotate” form appears where you choose the type information needed, press the “Annotate” button and select the corresponding entities.

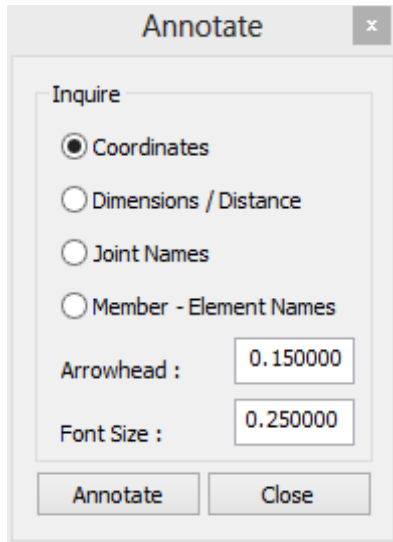

The available inquire options are:

- *Coordinates* of a specific Joint or AutoCAD Point. Immediately after selecting this you have to select one Joint or Point.
- *Dimension/Distance* between two Joints or AutoCAD points. Immediately after selecting this you have to select two Joints or Points.
- *Joint Names* to display the name of a specific joint. Immediately after selecting this you have to select one Joint.
- *Member or Element Names*. Immediately after selecting this you have to select one Member or Shell.

You can also control the size of the fonts and the arrowhead.

2.5.44. Select CAD Modeler's entities

You can use all AutoCAD's selection functions (window, crossing, pick, etc) to select CAD Modeler's structural entities. In addition, there is a command to help you selecting entities, having functionality similar to GTMENU. You can access this command from the ribbon command  **Select** or by typing `GTSSelect` at the command prompt. The "GTS Select" form appears where you can set the selection options.

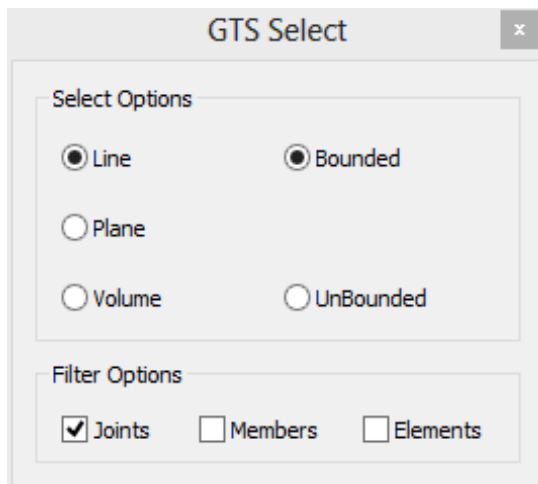

- Bounded Line Selection: All entities that lie on a Line
- UnBounded Line Selection: All entities that lie on a Line or its extension
- Bounded Plane Selection: All entities that lie on a Plane
- UnBounded Plane Selection: All entities that lie on a Plane or its extension
- Bounded Volume Selection: All entities that is located inside a Volume
- UnBounded Volume Selection: All entities that is located inside a Volume or its extension

Moreover, you can choose to filter only Joint, Members and Elements during the selection.

2.5.45. Display Deformed Structure

You can view the deformed shape of the structure from the menu “*GTS Display>Deformed Structure*” or by typing `GTSDisplayJointDisplacements` at the command prompt. You must then immediately select the load case, press ENTER, and then give the desired scale factor.

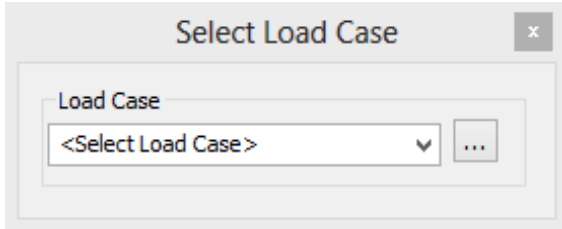

You can switch back to original view from the menu “*GTS Display>Undeformed Structure*” or by typing `GTSResetJointDisplacements` at the command prompt.

Note that Deformed Structure can be displayed in both 3D and Wireframe views of your model and that you can also switch between levels using the Levels Form or the Upper Level, Lower Level icons.

2.5.46. Display Joint Loads

You can view the joint loads applied in the structure from the menu “*GTS Display>Joint Loads*” or by typing `GTSDisplayJointLoads` at the command prompt.

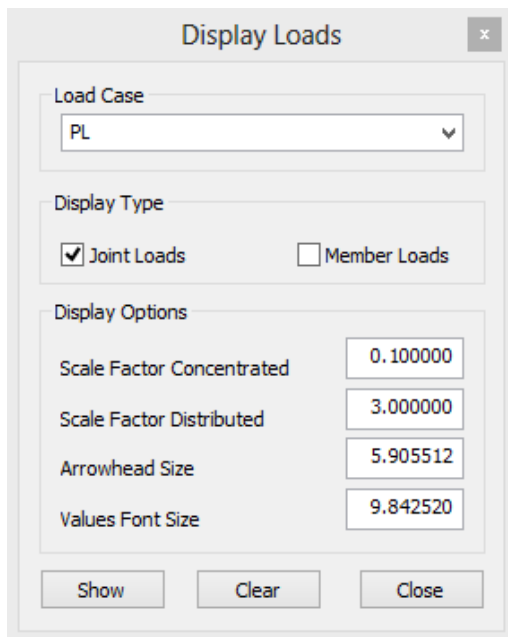

The “Display Loads” form appears where you can select the desired *Load Case*, the *Scale Factor* for Joint Loads, *Arrowhead Size* and the *Font Size*. The “Show” button displays the load arrows, and the “Clear” button erases them.

2.5.47. Display Member Loads

You can view the member loads applied in the structure from the menu “*GTS Display>Member Loads*” or by typing `GTSDisplayMemberLoads` at the command prompt.

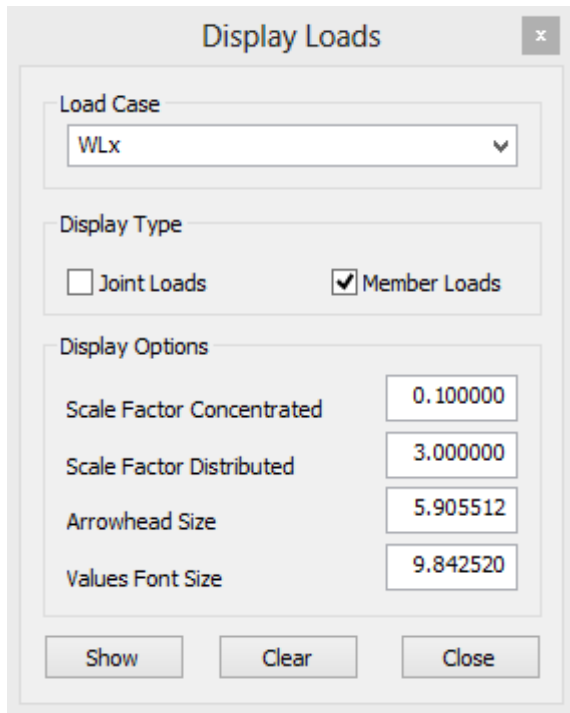

The “Display Loads” form appears where you can select the desired Load Case, the Scale factor for Concentrated or Distributed Member Loads, Arrowhead Size and the Font Size. The “Show” button displays the load arrow, and “Clear” button erases them.

2.5.48. Display Member Diagrams

You can view the force and moment diagrams from the menu “*GTS Display>Member Diagrams*” or by typing `GTSDisplayMemberForces` at the command prompt. You must then select the load case, press ENTER, and then choose the desired diagram to be displayed <1>N, <2>Qy, <3>Qz, <4>Mxx, <5>Myy, <6>Mzz, by giving the corresponding integer value.

2.5.49. Display Finite Element Results

You can view the finite element results from the menu “*GTS Display>Element Results*” or by typing `GTSDisplayElementResults` at the command prompt. You must then select the load case, press ENTER, and then choose the desired item to be displayed <33>Stress, <34>Strain, <35>Resultants, <36>Principal Stress, <37>Principal Strain, <38>Principal Membrane Resultant, <39>Principal Bending Resultant, <40>Von Misses, by giving the corresponding integer value. For some such as stresses, you will be asked to specify the surface (top <1>, middle<2>, or bottom<3>) by giving an integer number corresponding to the surface.

2.5.50. Display Member Code Check Results

You can view the pass/fail result of a Steel Code check or design from the menu “*GTS Display>Member Code Check Results*” or by typing `GTSColorCodeCheck` at the command prompt. You must then select the load case and the steel members which passed the code check will appear in blue, those that fail the code check will appear in red and those that were not included in the code check will appear in white.

2.5.51. Clear Results Layer

You can clear the displayed results, hide the Legend form of the contours and return to model by selecting from the menu “*GTS Display>Clear Results Layer*” or by typing `GTSDisplayResultsClear` at the command prompt. This command should be given after any of the previous “display” commands.

2.5.52. Version

The current version of CAD Modeler can be displayed by selecting from the menu “*GTS Display>Version*” or by typing `GTSVersion` at the command prompt. The current version will be displayed at the command line: `The current version of CAD Modeler is xxxx`

3. Tutorial Example #1

3.1. Introduction

The modeling of a three story building using CAD Modeler shown below is demonstrated in a step-by-step process.

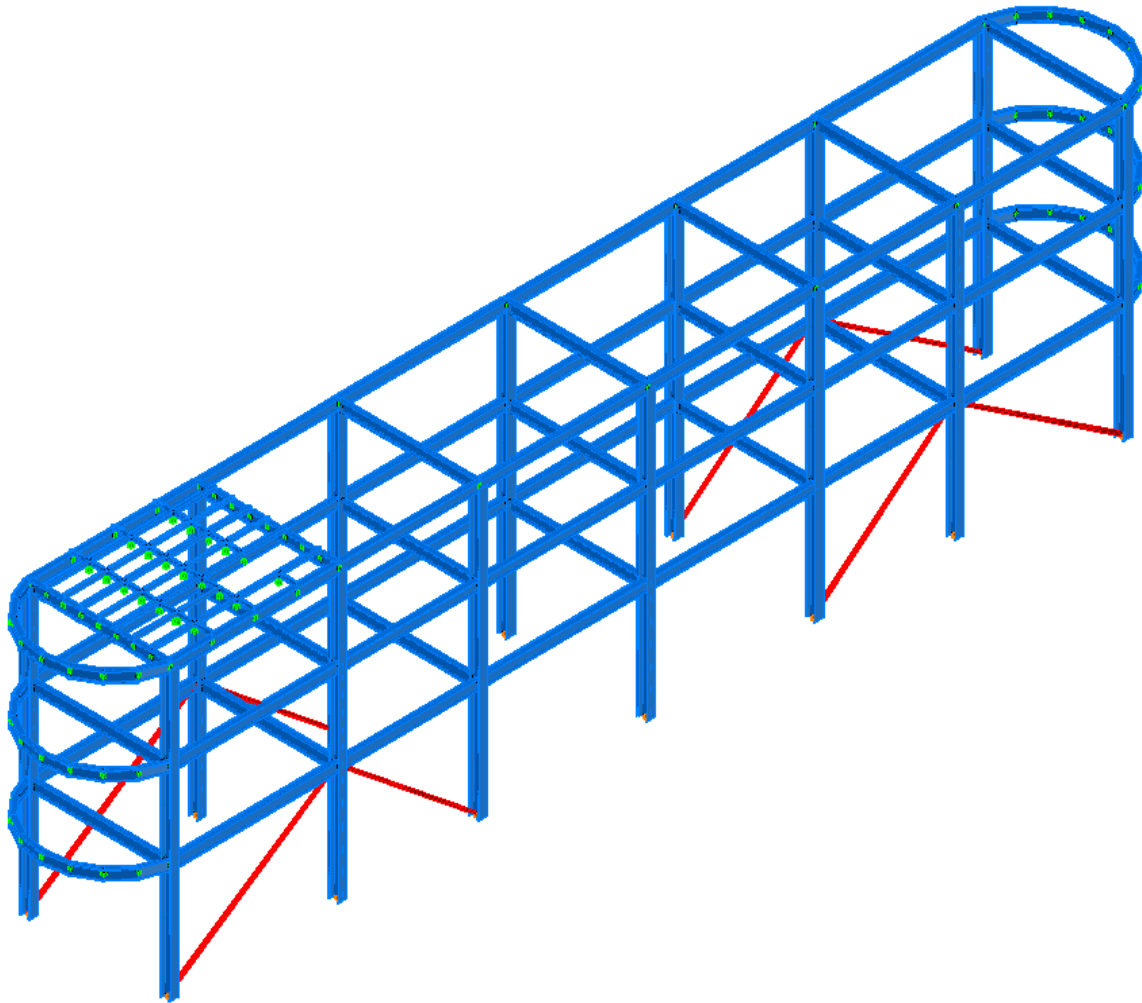

3.2. Open CAD Modeler and start working

Step #1. Launch GT STRUDL by selecting the icon “CAD Modeler” in the Welcome to GT STRUDL dialog shown below. The version of AutoCAD selected during the installation will be automatically launched, together with CAD Modeler’s menus and ribbons.

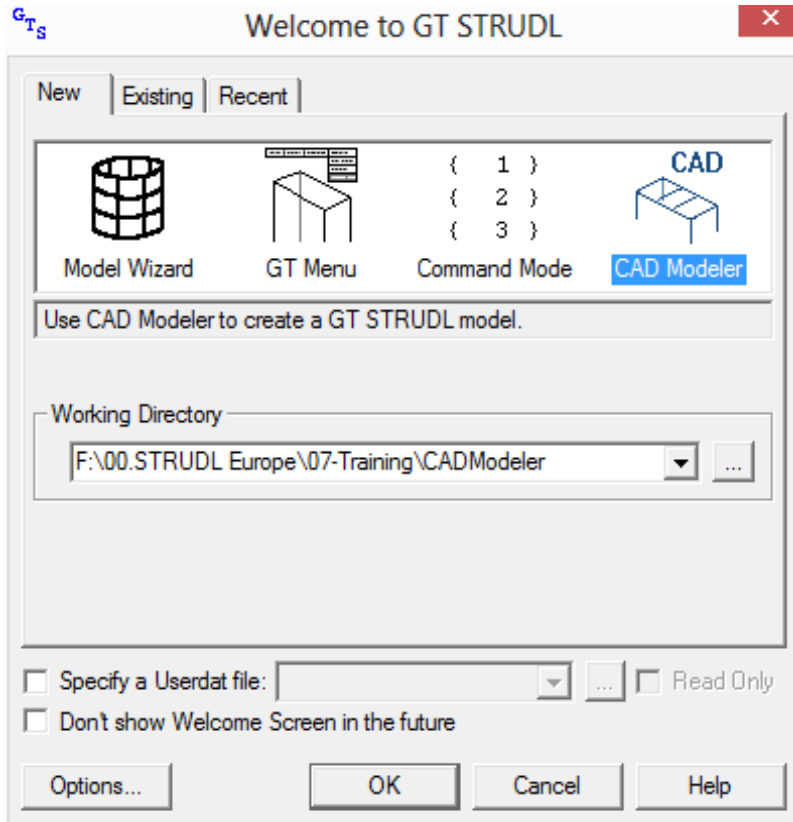

Step #2. Make sure that CAD Modeler’s ribbons and menus are visible.

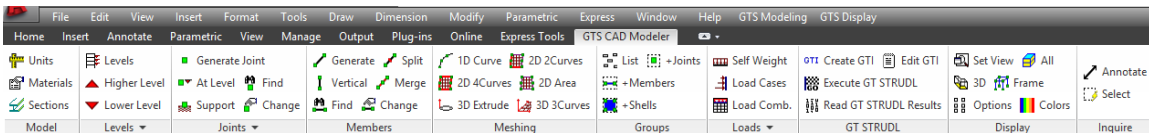

If AutoCAD’s menu is not visible, type `MENUBAR` at AutoCAD’s command prompt, then `1` and press `<ENTER>`.

If AutoCAD’s ribbon area is not visible, type `RIBBON` and press `<ENTER>`.

Ribbon commands will be used in this tutorial example. However, since all ribbon commands appear in the menu area, you can use the menu bar as well.

3.3. Define the basic geometry of the model

Step #3. Define the correct Units by pressing the icon  **Units** and select *Meters (m)* and *KiloNewtons* in the *Units Form*.

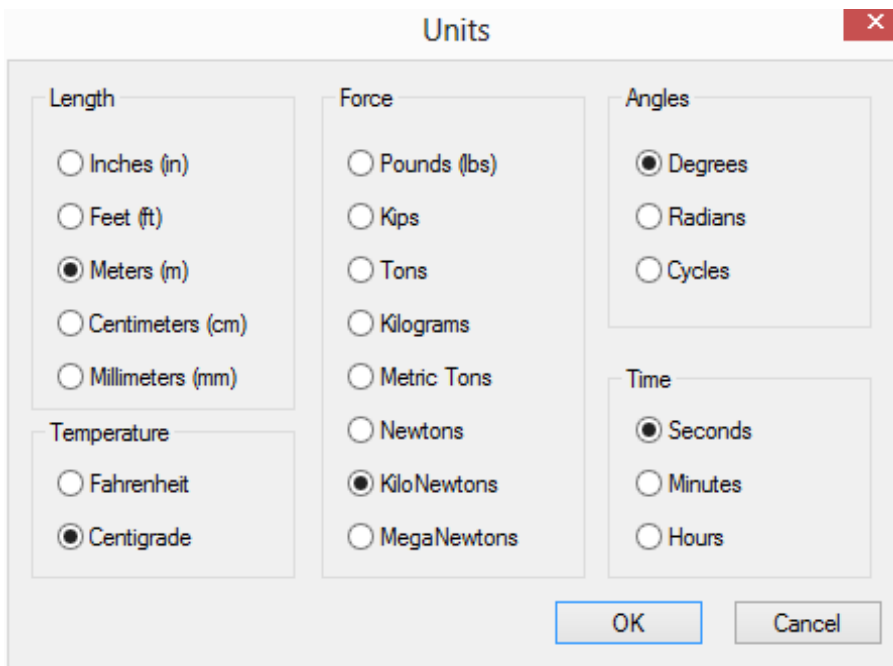

Step #4. Enter the cross-section profiles that will be used at the model by pressing the icon  [Sections](#) . Click on the *European* list and then on the *HEB* table of profiles. Select the profile *HE320B*, that will be used for the columns, by double clicking on it.

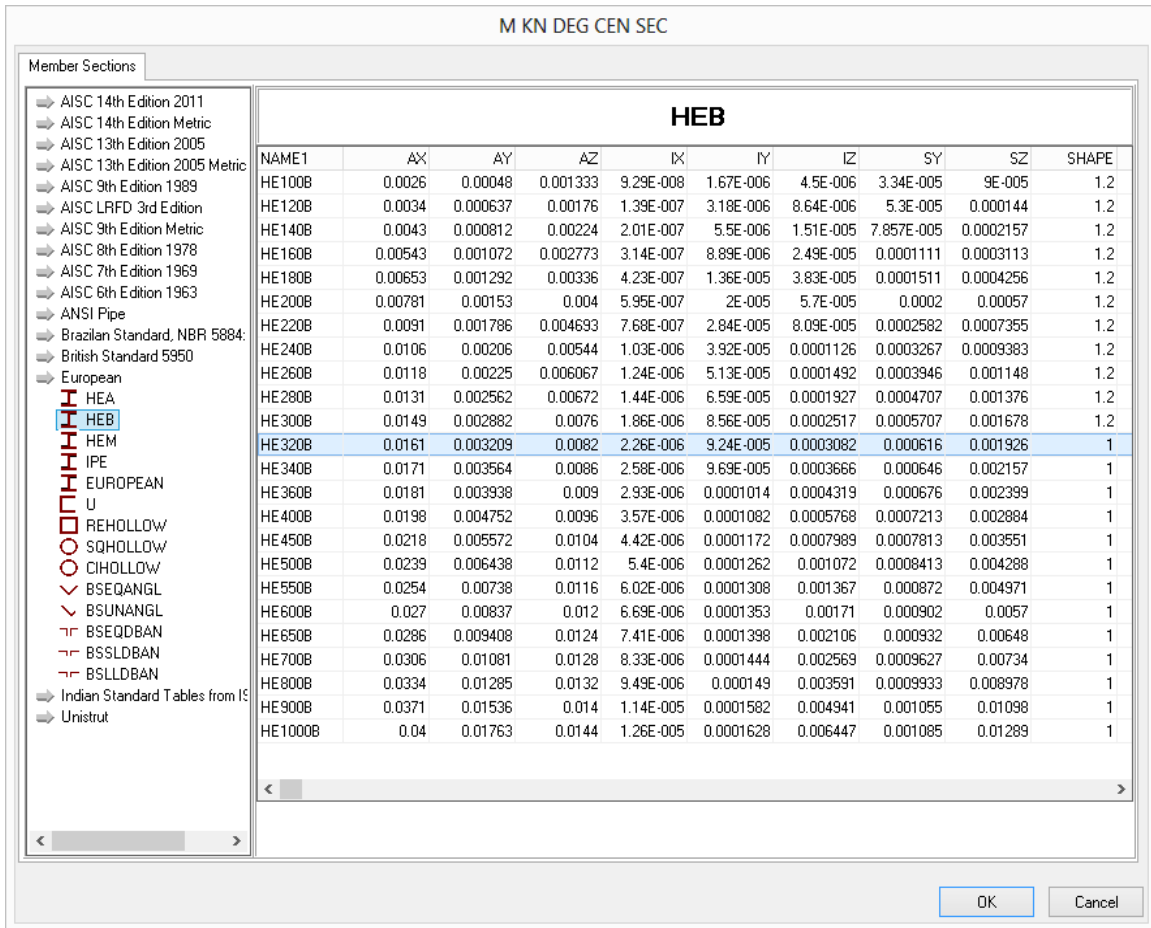

- ➔ European
- H HEA
- H HEB
- HE320B
- H HEM
- H IPE
- IPE330
- IPE120
- H EUROPEAN
- U
- REHOLLOW
- SQHOLLOW
- CIHOLLOW
- BSEQANGL
- 60x60x5
- BSUNANGL
- BSEQDBAN
- BSSLDBAN
- BSLLDBAN

The profile is added to the project and it appears in the left list-box having a black dot in front of it.

Using the same procedure, add 3 additional profiles: *IPE330*, for beams, *IPE120* for the girders from table *IPE* and *60x60x5* for the bracing from the table *BSEQANGL*. Press **OK** to close the form.

Note: You can add additional profiles at any time by following this procedure and also view the full list of profiles used in your model and add more profiles if needed.

Step #5. Define the 3 levels of the model by pressing the icon  **Levels** . Press the *Add Level* button 3 times to add 3 levels to your model. Modify the height of the 1st level by selecting the *Height* cell of the 1st Level and entering 4. Make sure that *Z Vertical Axis* option is checked and press **OK** to close the form.

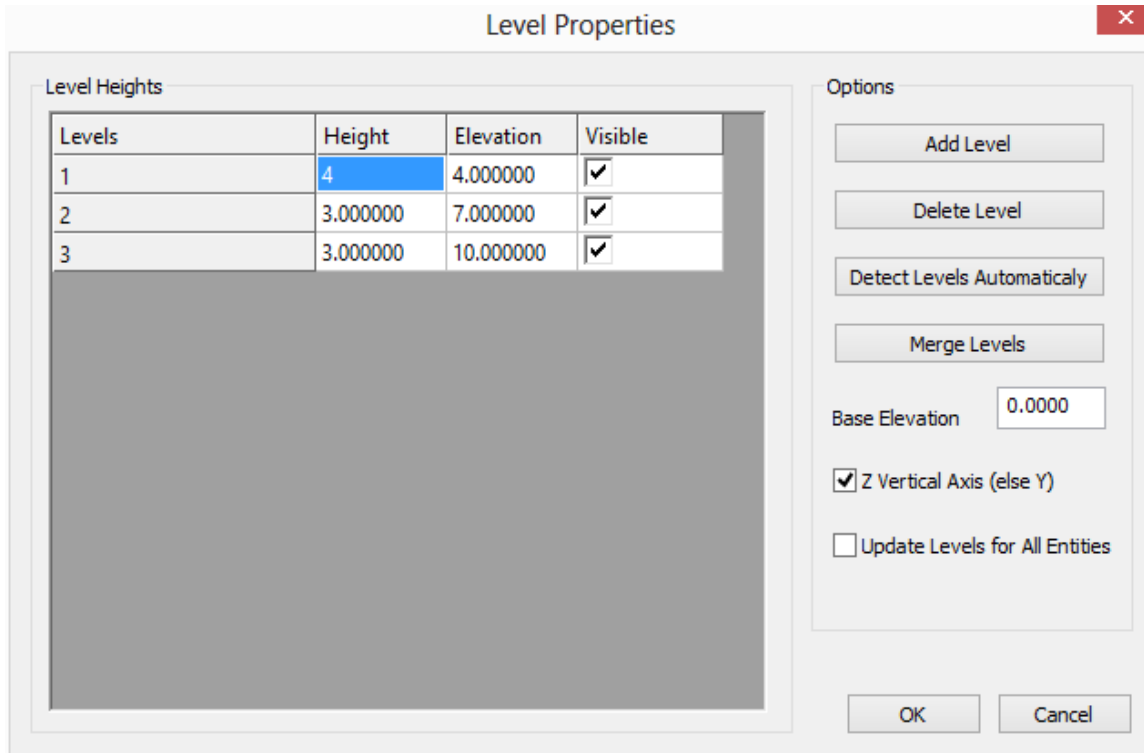

Levels	Height	Elevation	Visible
1	4	4.000000	<input checked="" type="checkbox"/>
2	3.000000	7.000000	<input checked="" type="checkbox"/>
3	3.000000	10.000000	<input checked="" type="checkbox"/>

Options

Add Level

Delete Level

Detect Levels Automatically

Merge Levels

Base Elevation: 0.0000

Z Vertical Axis (else Y)

Update Levels for All Entities

OK Cancel

Step #6. Enter a Grid that will help you enter the columns quickly by clicking on the icon  **Grid** that appears by clicking on the **Levels** ribbon tab to expand it. The grid is going to have 3 spaces (6m, 5m, 6m) in the horizontal direction (X) and 1 space (5m) in the sidelong direction (Y). Enter 6 in the *Distance* text box and press the *Add* button. Repeat by entering 5 and *Add*, and 6 and *Add*.

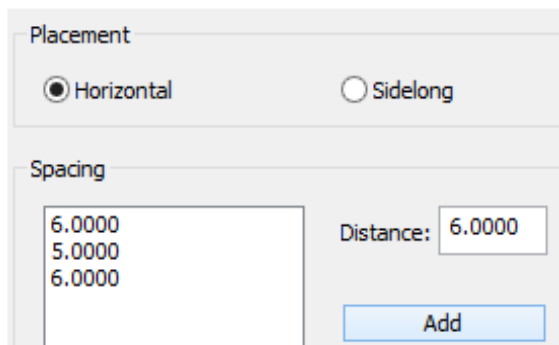

Placement

Horizontal Sidelong

Spacing

6.0000
5.0000
6.0000

Distance: 6.0000

Add

Then, click on *Sidelong* in the *Placement* area to enter the spacing in the Y direction, and enter 5 and *Add*.

By pressing **OK** you are prompted to enter the Insert Point for the grid. Type 0, 0, 0 and press **<ENTER>**.

The grid is created, having its upper left corner A-1 at the point 0,0,0.

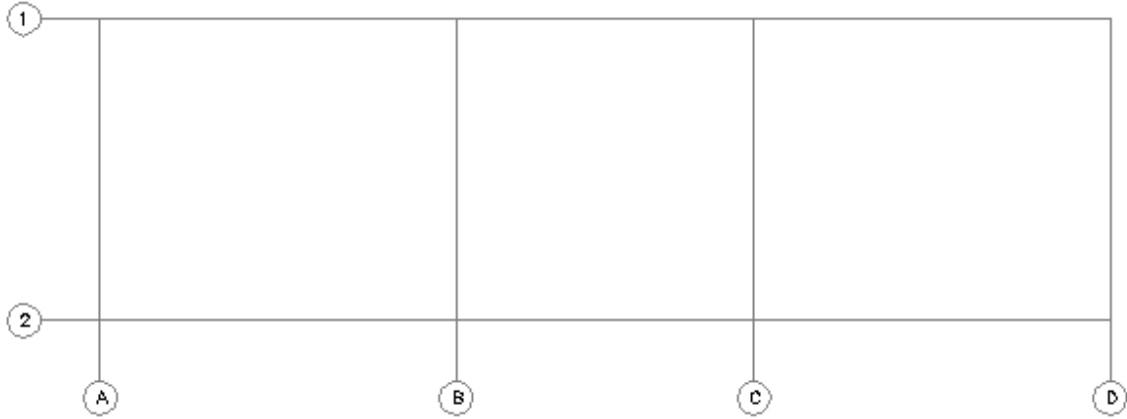

You will be able to view the grid by pressing the Top Icon in AutoCAD's View Cube, or preferably by typing Z (for Zoom), E (for Extents) and press <ENTER> .



3.4. Create the 1st floor

Step #7. Start entering the columns by clicking on the icon  **Vertical** and the pop-up dialog *GTS Member* appears at the upper left corner of the screen.

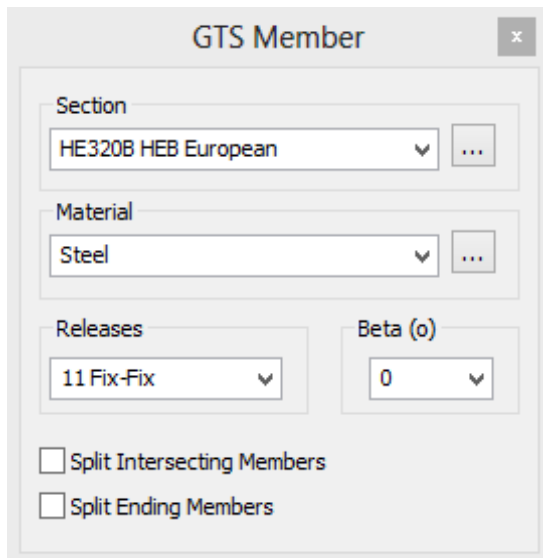

This dialog helps you to quickly select properties for the members that are going to be entered. Select *HEB320B* as the cross section for the columns. Make sure that *Material* is set to *Steel*, *Releases* to *Fix-Fix* and the *Beta* angle is *0*. There is no need to close this dialog manually.

Click at the intersection point between line A and line 1 (point A-1) and the column will be placed at this position. Repeat the same procedure by clicking at the points B-1, C-1, D-1, A-2, B-2, C-2 and D-2.

When you are done, press ESC to exit the Vertical column command. The GTS Member form is automatically hidden.

Step #8. You can easily change to an isometric view of the structure by pressing the small house icon in AutoCAD's View Cube.



As you can see in the isometric view below, column members 1 to 8 were created together with joints 1 to 16 at their ends. Each column is 4.00m long, as defined in Level Properties (height of the first floor).

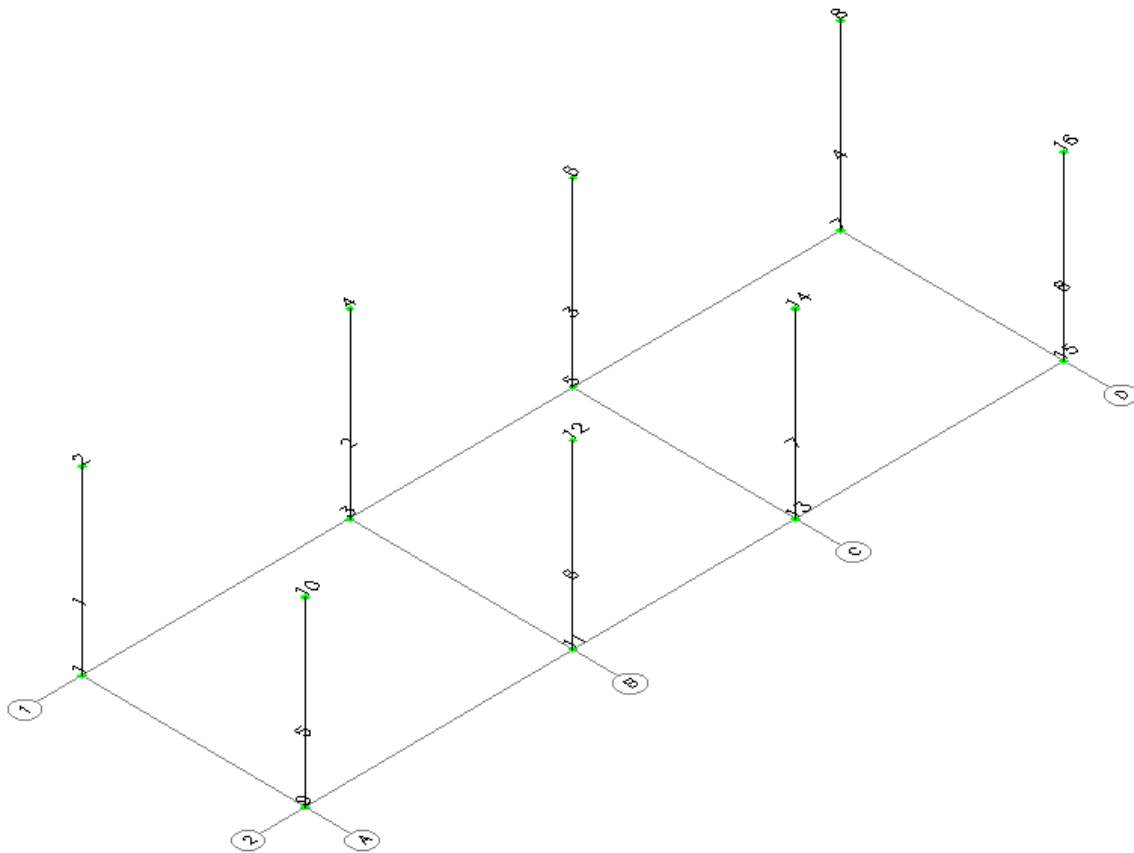

Step #9. Start entering the beams, along X axis, by clicking on the icon  **Generate** and the prompt message *Starting Point (x,y,z)* appears, asking you to enter the coordinates or click on a specific point on screen. Click on Joint 2 at the top joint of column 1 at position A-1.

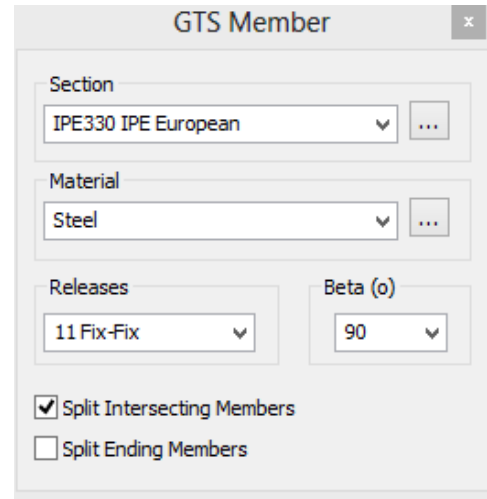
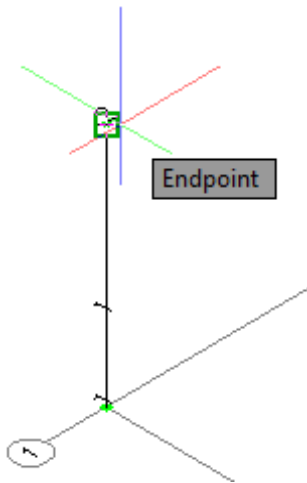

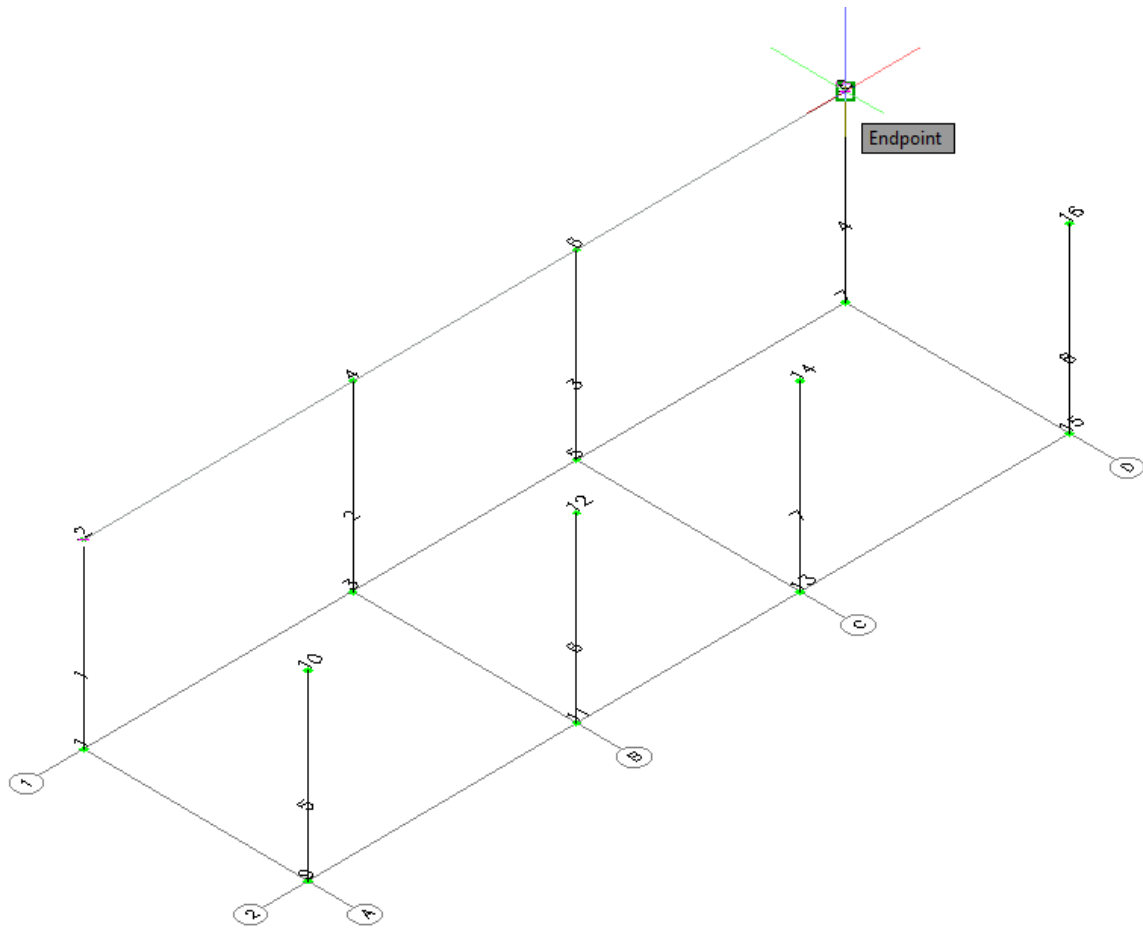

Select *IPE330* as the cross section and make sure that *Material* is set to *Steel*, *Releases* to *Fix-Fix* and the *Beta* angle is *90*. You have to set the *Beta* angle equal to *90* degrees in order to orientate the local *Y* axis of the *IPE* cross section along the *Z* global axis. Moreover, make sure that the option *Split Intersecting Members* is checked, to create the three beams along *X* axis with only two clicks of the mouse: at joints 2 and 8. The beam from joint 2 to joint 8, will be split into three parts, between joints 2, 4, 6 and 8, since joints 4 and 6 (columns at positions B-1 and C-1) intersect this member.

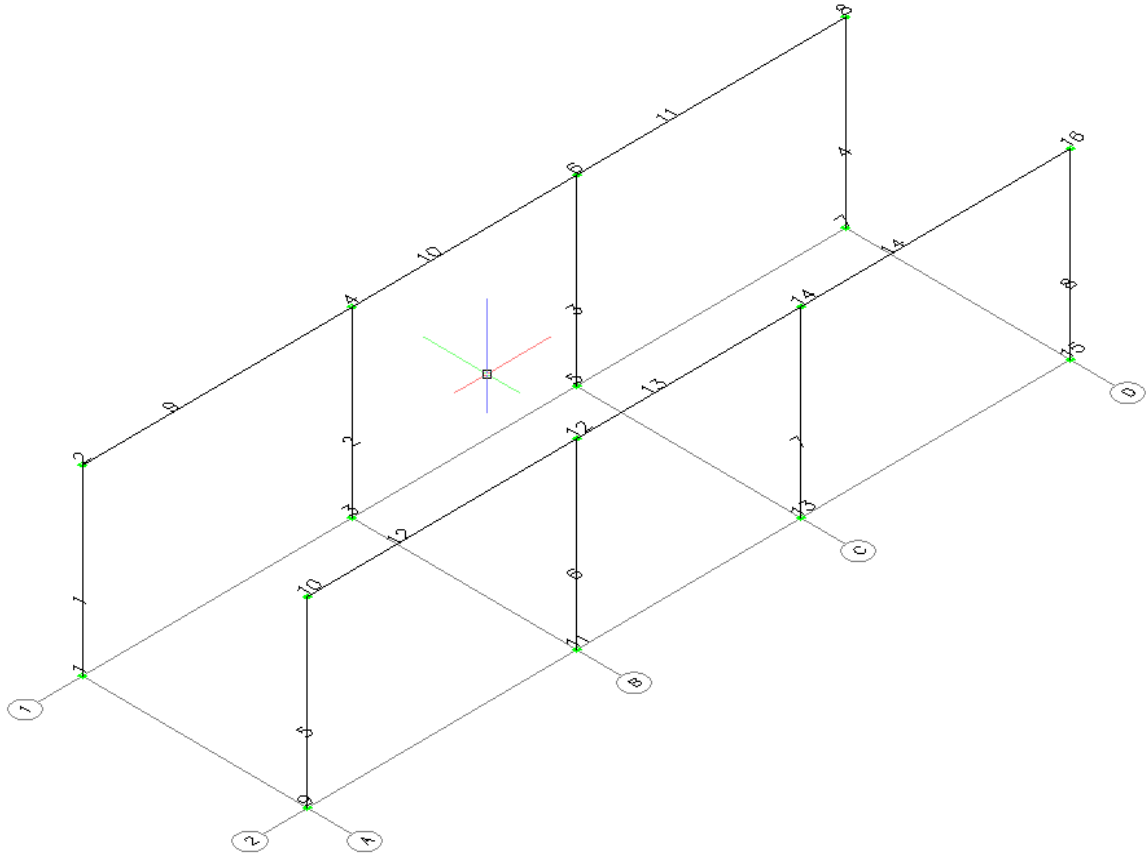

Then you have to define the *Ending Point* (x,y,z) so click at joint 8, as shown in the picture above. Members 9, 10 and 11 will be created.

Since the command is still active, you are prompted to enter the *Starting Point* (x,y,z) , repeat the same procedure by clicking on joint 10 (top of column at position A-2), check *Split Intersecting Members* and then click at joint 16 (top of column at position D-2). Members 12, 13 and 14 will be created.



Step #10. Enter the beams, along Y axis. The command Generate Beams should be still active, else you can call it again by clicking again on the icon  **Generate**. The prompt message *Starting Point (x,y,z)* appears, asking you to enter the coordinates or click on a specific point on screen. Click on the Joint 2, that is the top of column at position A-1, keep the same settings as in the previous step, regarding the cross section and Beta angle, but do NOT click on *Split Intersecting Members*. In order to define the *Ending Point (x,y,z)* click at joint 10 (top of column at position A-2). Member 15 is generated.

Repeat the same procedure by clicking on the joints 4 and 12 to generate member 16, joints 6 and 14 to generate member 17 and joints 8 and 16 to generate member 18. Then, press ESC to terminate the command.

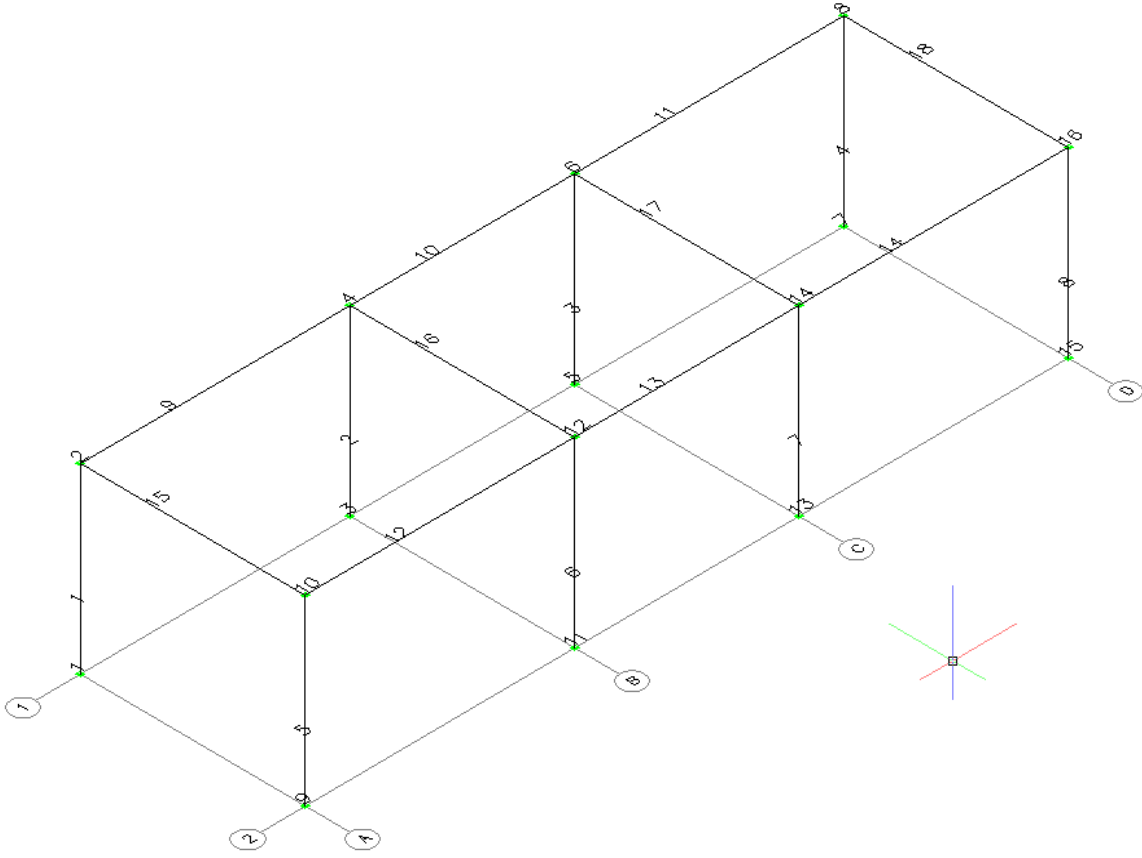

Step #11. Create an arc on the right side of the structure:

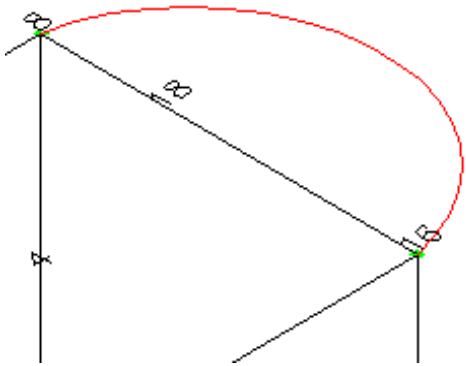

Type ARC and

- in order to *Specify start point of arc or [Center]*: click on joint 8,
- to *Specify second point of arc or [Center/End]*: type 19, -2 and press <ENTER> and
- to define the end point of arc: click on joint 16.

Step #12. Generate Members along the Arc: Click on the icon  1D Curve and when the prompt message *Select Curve (Line or Arc)* appears, click on the Arc that you have created in the previous step.

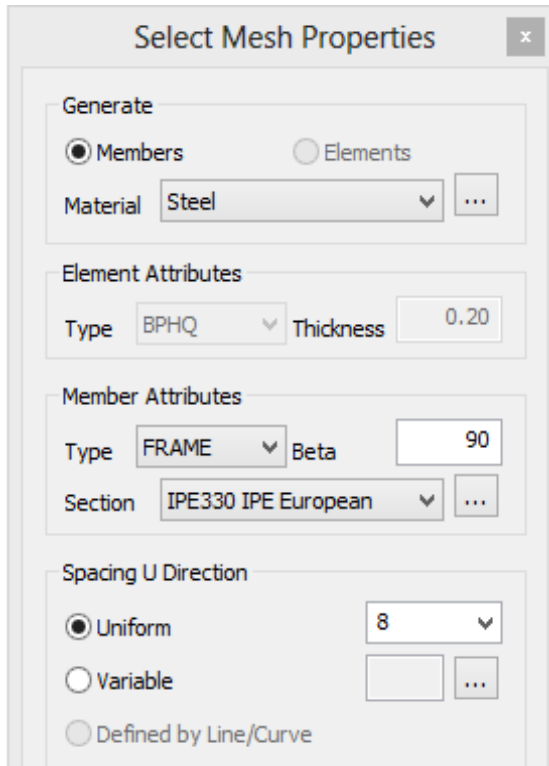

The Select Mesh Properties form appears where you have to enter:

- Material : Steel
- Beta Angle: 90
- Section: IPE330
- Spacing U Direction: Uniform 8

This command is going to generate 8 linear members equally spaced along the arc.

You can press Preview button to see the members as they will be generated.

Press the Create button and 8 members, named 19 to 26, were created and 9 joints, named 17 to 25 were created along the arc.

Note that joints 17 and 25 are created on the top of joints 16 and 8 correspondingly. Later on, they are going to be merged together by deleting duplicate joints.

Step #13. Hide Grid: Since the Grid is no longer needed it can be hidden using AutoCAD commands to freeze the layer GRID_LAYER. This can be done by clicking on the Home Tab and then selecting the GRID_LAYER from the drop down list of layers and clicking on its freeze icon.

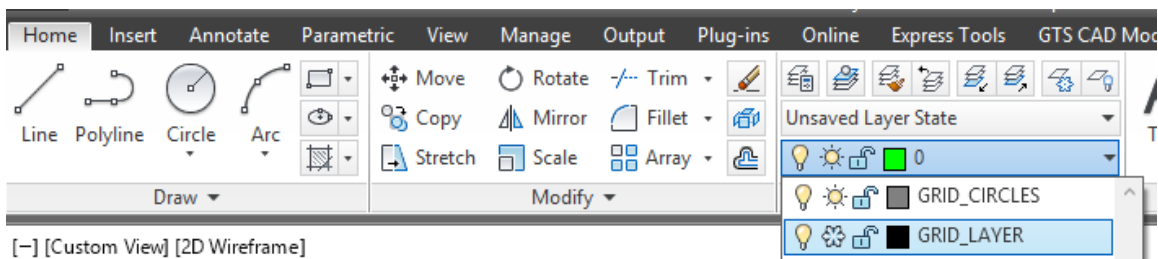

Step #14. Turn OFF labeling:

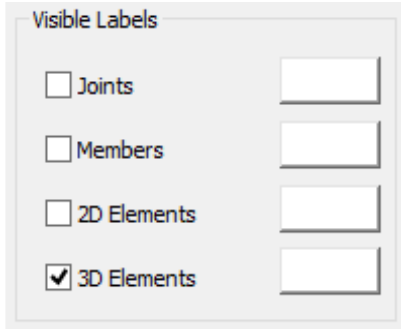

Click on the icon  **Options** in the ribbon bar and then uncheck the Visible Labels option for Joints, Members and 2D Elements.

Now labeling is turned off and it is easier and faster to control the model.

Note: You can also delete or hide the Arc line as it is no longer needed.

Step #15. Mirror the structure: Switch to a floor pan view, by pressing the TOP of AutoCAD's View Cube.

Then, type MIRROR and when you get the notification *Select objects*: select the right part of the structure, but not the members and joints that are on the mirror line. In order to make this selection, make the 1st and the 2nd click of the mouse at the points 1 and 2 as shown in the picture bellow and press <ENTER>. You will get a confirmation that 44 objects were found (or 45 if you still have the arc).

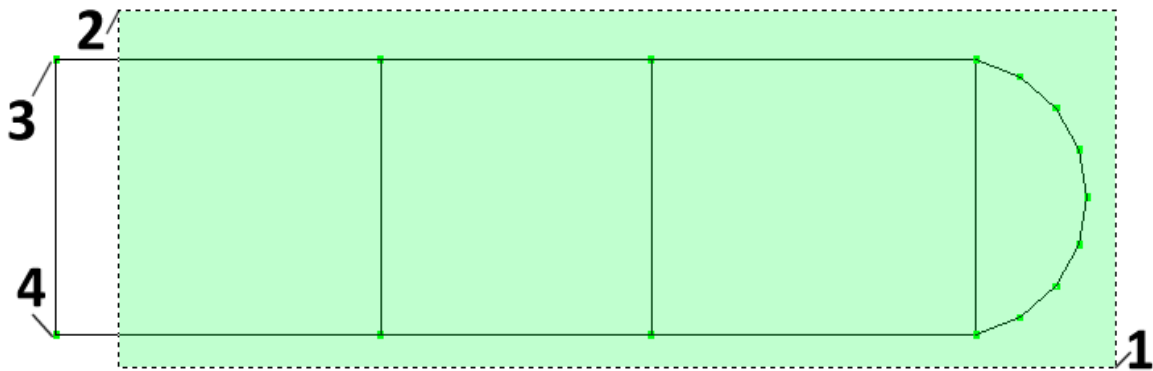

When you get the message *Specify second point of mirror line*, click on the joints at points 3 and 4 as shown in the picture above.

Then, press <ENTER> and reply to the question *Erase source objects? [Yes/No] <N>*: , so as not to delete the right part of the structure. The structure after the mirror command will look like the following picture:

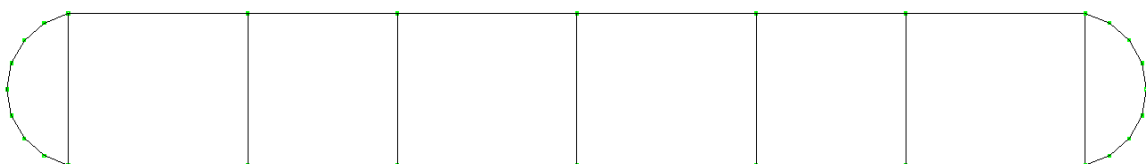



Step #16. Switch to 3D View: Press the house icon to change the view to Isometric, and type Z and E (Zoom, Extents). Click on the icon  Colors to set different colors for each profile.

Sections	Color	Visible
HE320B	161	<input checked="" type="checkbox"/>
IPE330	191	<input checked="" type="checkbox"/>
IPE120	1	<input checked="" type="checkbox"/>
60x60x5	50	<input checked="" type="checkbox"/>

Press OK to close the Color Options Dialog. Each cross section will now have a different color .

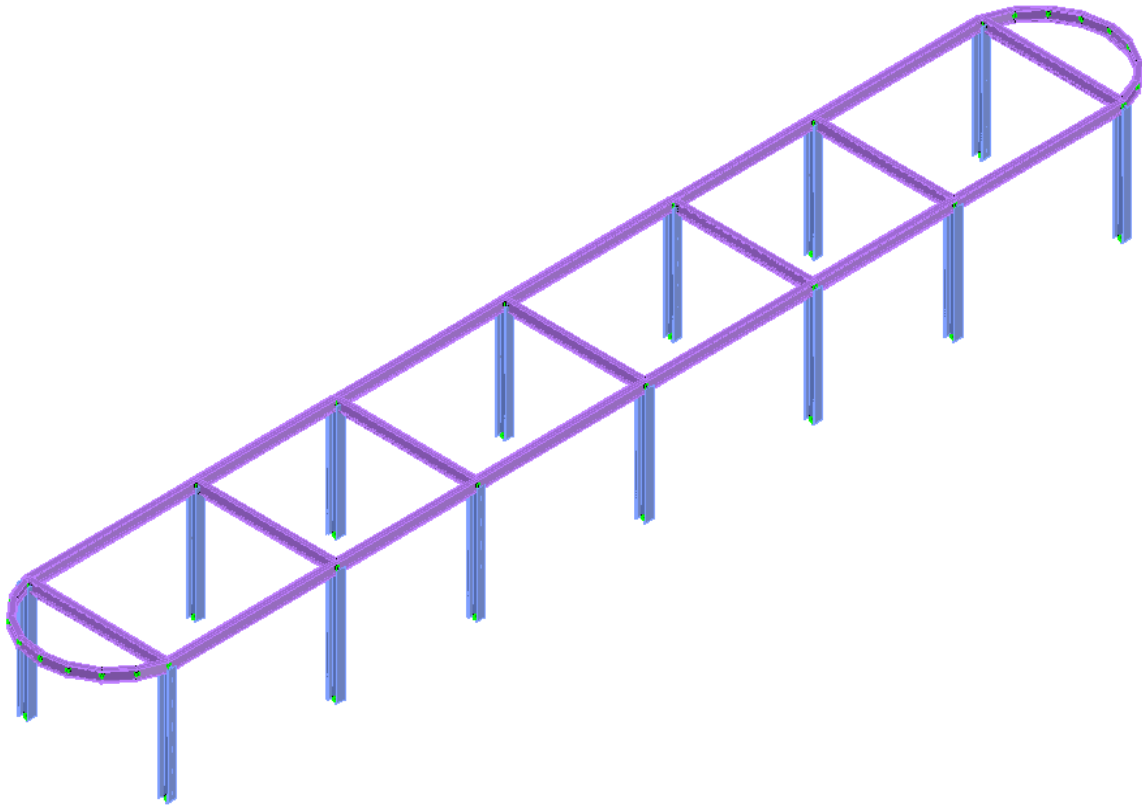
Press the icon  3D to display the 3D solid view of the model, replacing the wireframe view:



Press the icon  Frame to switch back to wireframe view to be able to process CAD Modeler's and AutoCAD's commands faster.

Step #17. Save your Model: In order to save your model just use AutoCAD's save command and store the DWG using any filename that you want.

3.5. Create the 2nd floor

Step #18. Copy the members and joints of the 1st floor to the 2nd: Type the command `COPY` and when asked to *Select objects*: type `ALL`, so that everything is selected. You will get a verification that 101 objects were found and then press `<ENTER>`.

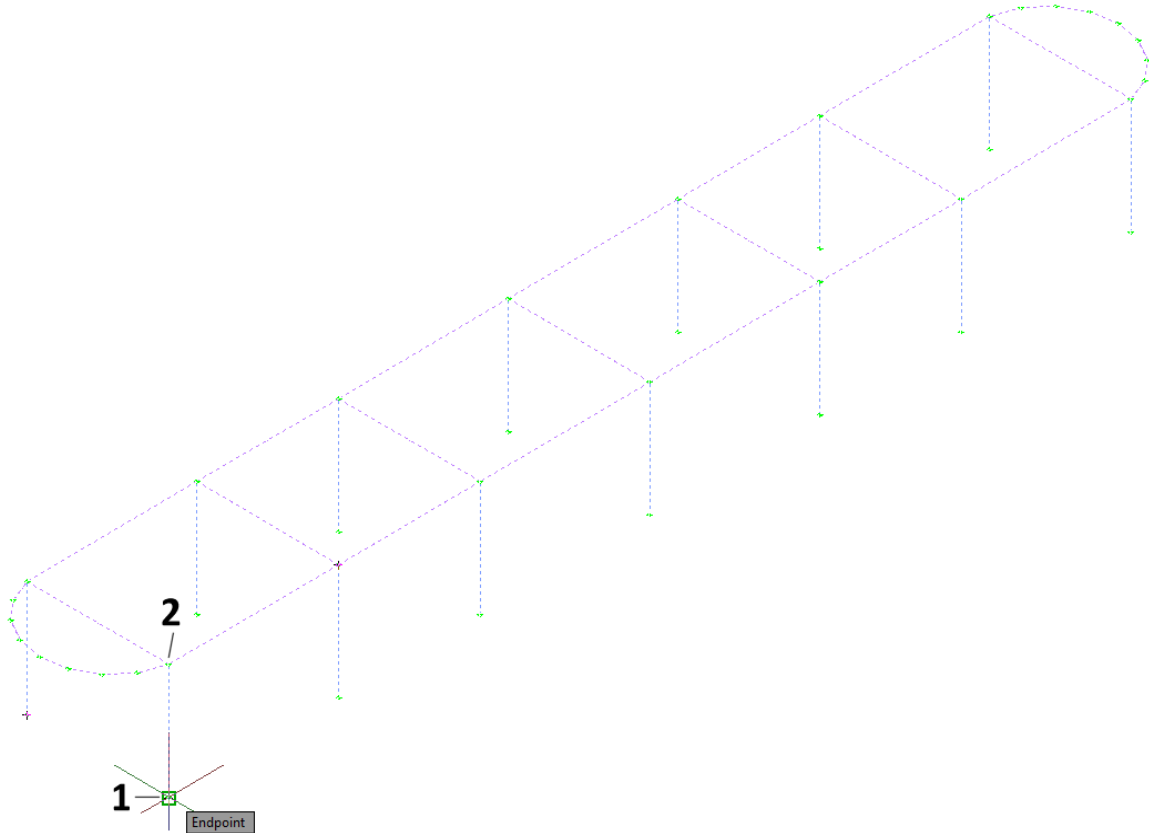

In order to *Specify base point or [Displacement/mOde] <Displacement>*, click at the base of any column such as point 1 in the picture above.

In order to *Specify second point or [Array] <use first point as displacement>*: click at the top of the same column such as point 2 of the picture and then press `<ENTER>` in order to terminate the copy function.

All entities of floor 1 are now copied to floor 2.

Step #19. Correct the Z coordinates of the 2nd floor: The copied columns are 4.00m long, since they were copied from the 1st floor. In addition, the Z coordinate of the beams is equal to 8.00m instead of 7.00m. Therefore, all copied joints that have Z coordinate equal to 8.00m should be moved 1.00m lower.

Switch to FRONT View, by clicking on AutoCAD's view cube.

Type `MOVE` in order to initiate AutoCAD's move command and when asked to *Select objects*, click on points 1 and 2, as shown in the picture below, selecting all the entities that belong to the top of the 2nd floor. You will get a notification that 77 objects were *found* and press `<ENTER>`.

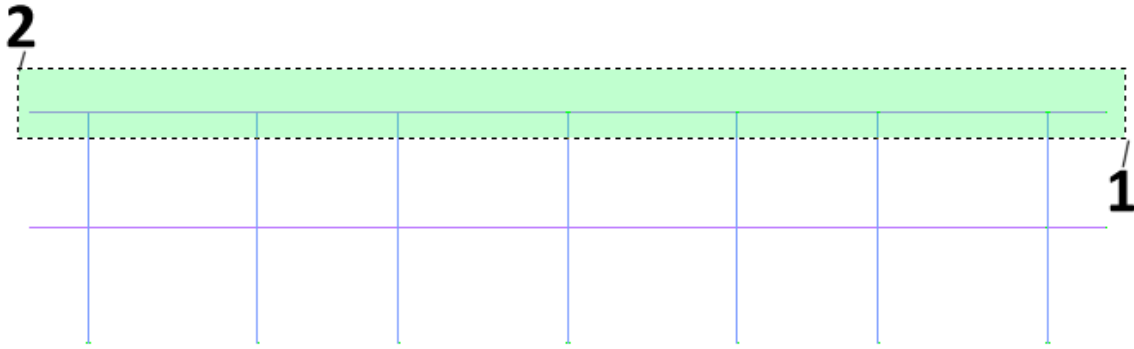

In order to *Specify base point or [Displacement] <Displacement>*: click ANYWHERE on the screen. It makes no difference where you click since relative coordinates will be use to define the displacement.

In order to *Specify second point or <use first point as displacement>*: type @0,0,-1 and press <ENTER>.

Now the height of the 2nd floor is correct and equal to 3.00 meters.

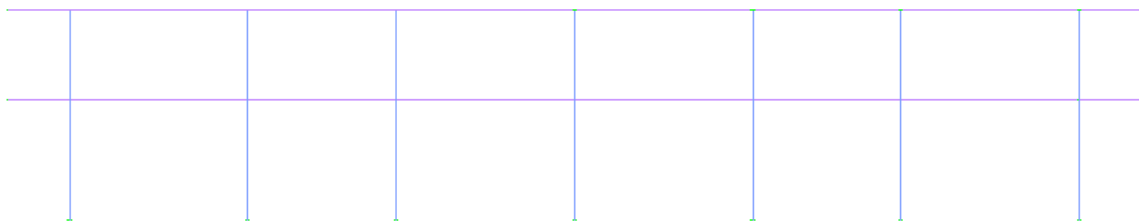

Note that you can reach the same result by switching to the 2nd Level using the icon  and start entering the columns one-by-one, as you did in the 1st Level. Columns will then have the correct height (3.00m), since the height of the second Level is defined equal to 3.00m when the levels were defined in a previous step. Then, copy only the beams from the 1st Level to the correct position. However, it is somewhat faster to copy everything and then fix the Z coordinate with a simple MOVE command as you did in the previous steps.

3.6. Create the 3rd floor

Step #20. Copy the members and joints of the 2nd floor to the 3rd : Type the command COPY and when asked to *Select objects*: click on the same two points that were used in the previous MOVE command as shown in the following figure.

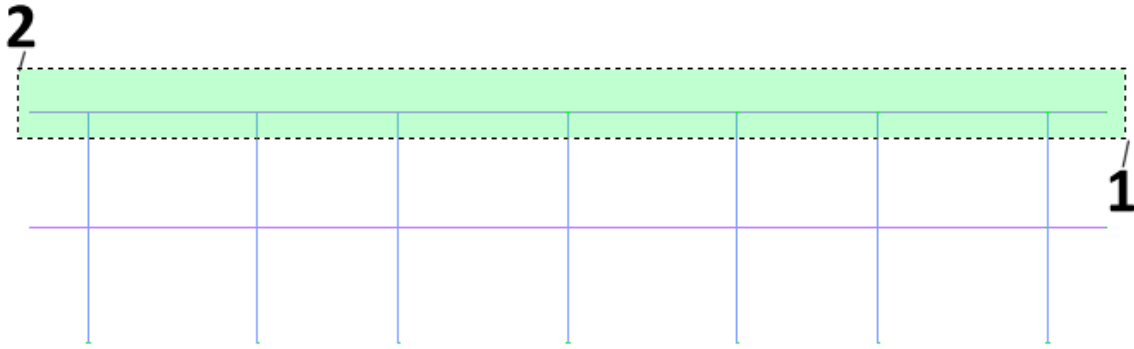

Since this is a crossing window, the columns are automatically selected. You will get a notification that 77 objects were *found* and press <ENTER>.

In order to *Specify base point or [Displacement] <Displacement>*: click ANYWHERE on the screen. It makes no difference where you click since relative coordinates will be used to define the displacement.

In order to *Specify second point or <use first point as displacement>*: type @0, 0, 3 and press <ENTER>.

Now the 2nd floor is copied to the 3rd one. There is no need to correct the Z coordinates as was done when the 2nd floor was moved since the second and third levels have the same height.

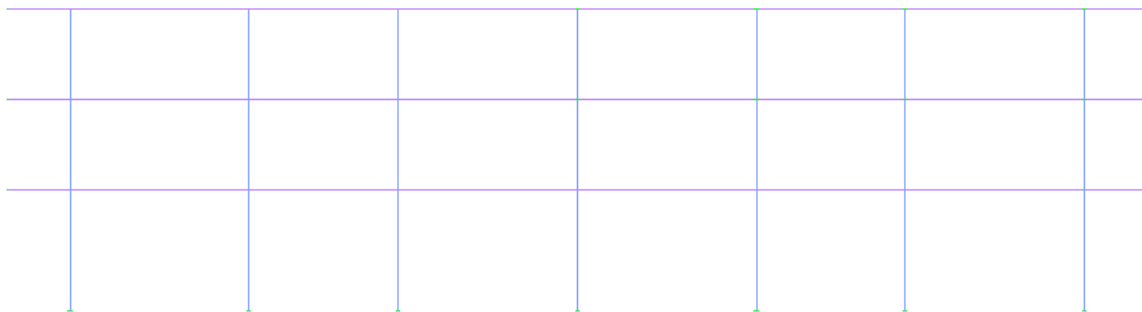

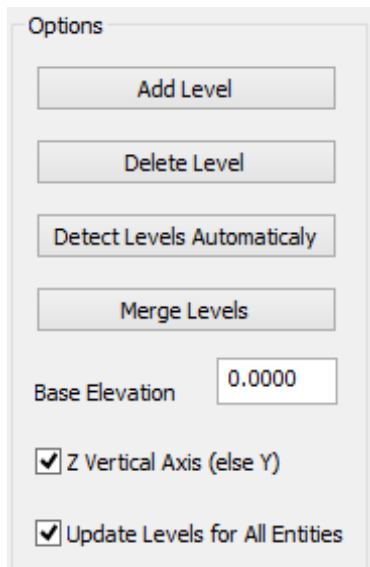

Step #21. Assign Level Properties:



Since all members were created from Level 1 using COPY commands, all of them belong to level 1 and their correct Level property should be assigned.

Click at icon  **Levels** , check the option Update Levels for All Entities and press OK.

Now every Member or Joint has the correct Level property depending on its Z coordinate.

You can switch between the levels of the model using the  **Higher Level** and  **Lower Level** icons. The current level appears in the top caption of AutoCAD's screen.

You can make whole structure visible by clicking on the icon  **All** .

Step #22. View and Save your model: Press the house icon to change the view to Isometric, and type Z and E (Zoom, Extents).

Press the icon  **3D** to display the 3D solid view of the model, replacing the wireframe view as shown in the following figure:

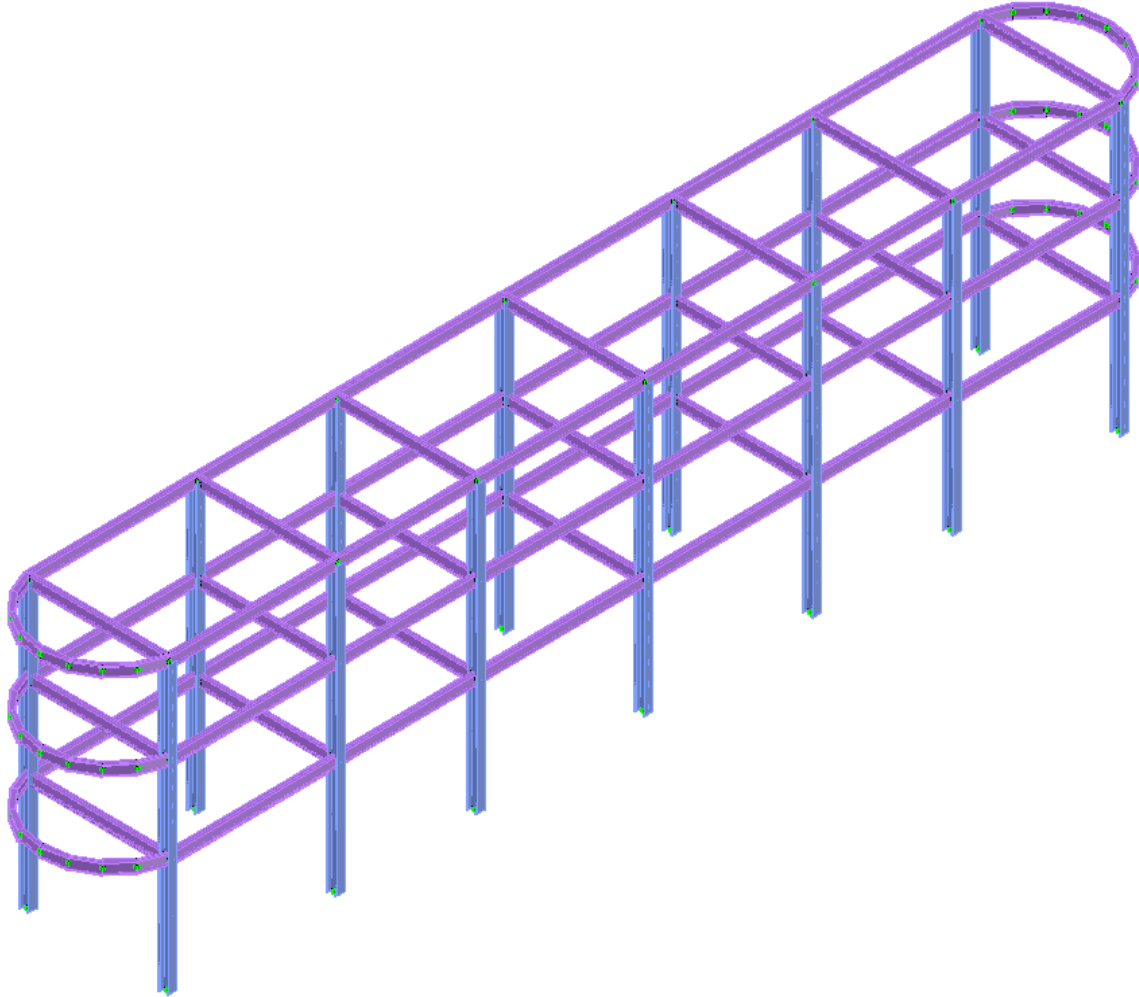

Save your model, using a different file name (Save As...). By saving your model with a different name each time, it is easier to back up to a previous state of the model.

3.7. Create bracing

Step #23. Place bracing members at the front:

Press the icon  Frame to switch back to wireframe view to be able to process CAD Modeler's and AutoCAD's commands faster.

Levels	Height	Elevation	Visible
1	4.000000	4.000000	<input checked="" type="checkbox"/>
2	3.000000	7.000000	<input type="checkbox"/>
3	3.000000	10.000000	<input type="checkbox"/>

Click at icon  Levels, check the visible property for level 1 and uncheck it for all other levels and press OK.

Now only Level 1 is visible and it is easier to add the bracing members.

Click on the icon  **Generate** and click on the joint located at Point 1 of the following image.

Select *60x60x5* as the cross section and make sure that Material is set to *Steel*, Releases to *Fix-Fix* and Beta angle is *0*.

Click on joint located at Point 2, and the first bracing member is created.

Click again on joint located at Point 2 and keep the same properties for GTS Member as defined before

Click on the joint located at Point 3, and the second bracing member is created.

Click on the joint located at Point 4 and keep the same properties for GTS Member.

Click on the joint located at Point 5, and the third bracing member is created.

Click again on the joint located at Point 5 and keep the same properties for GTS Member.

Click on the joint located at Point 6, and the fourth bracing member is created.

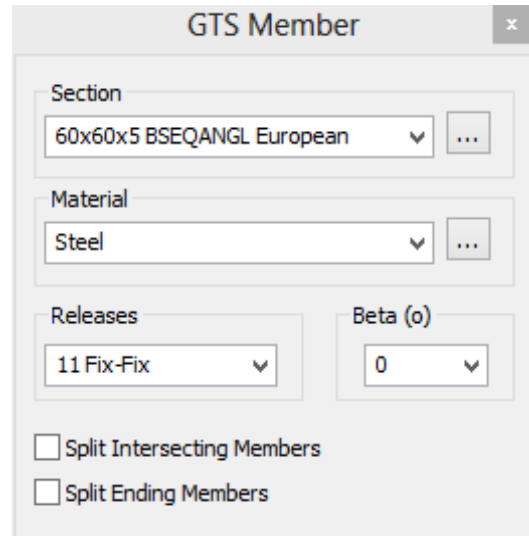

The image shows a software dialog box titled "GTS Member". It contains several configuration options:

- Section:** A dropdown menu set to "60x60x5 BSEQANGL European" with a "..." button to the right.
- Material:** A dropdown menu set to "Steel" with a "..." button to the right.
- Releases:** A dropdown menu set to "11 Fix-Fix".
- Beta (o):** A dropdown menu set to "0".
- Two checkboxes at the bottom: Split Intersecting Members and Split Ending Members.

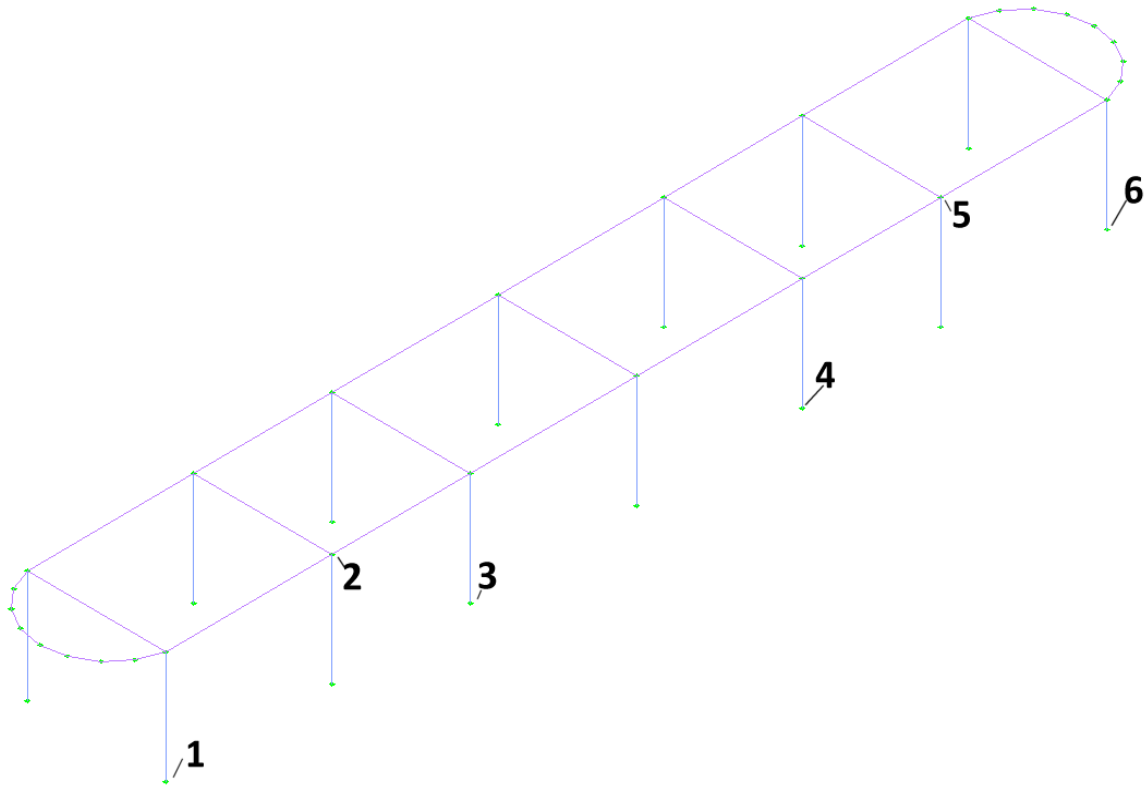

Press ESC to terminate the Generate Beam command.

Step #24. Change the properties of the Bracing Members: Click on the icon  **Change** in the Members panel and when asked to Select objects: click on the 4 bracing members created in a previous Step and press <ENTER>.

The Member Properties [Multiple Selection] form is displayed. Now, change the type to SPACE TRUSS and press OK.

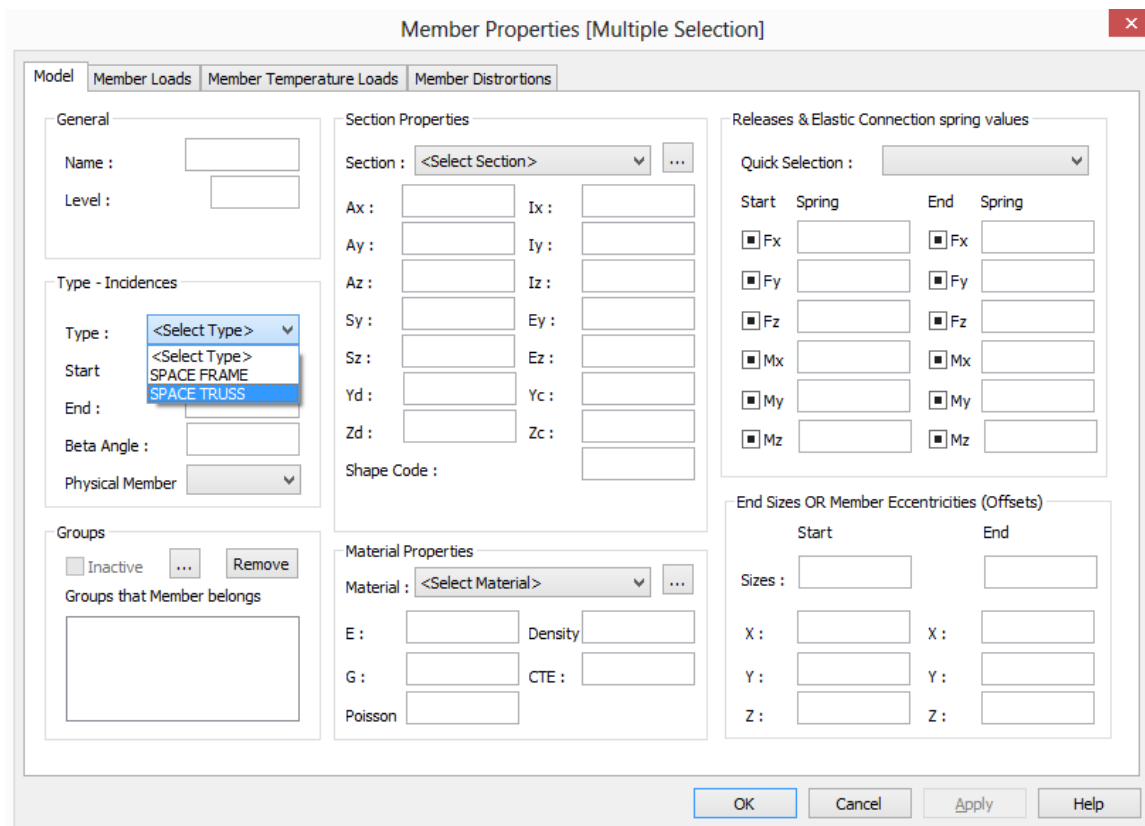

This modification applies to all selected members.

Step #25. Copy bracing member to the back: Type `COPY` and when asked to Select objects: click on the 4 bracing members created in a previous Step and press `<ENTER>`.

In order to define *Specify base point or [Displacement/mOde] <Displacement>*: click on the Joint at Point 1 of the following image.

In order to define *Specify second point or [Array] <use first point as displacement>*: click on the Joint at Point 2 inf the image on the next page.

Press `ESC` to terminate the `COPY` command.

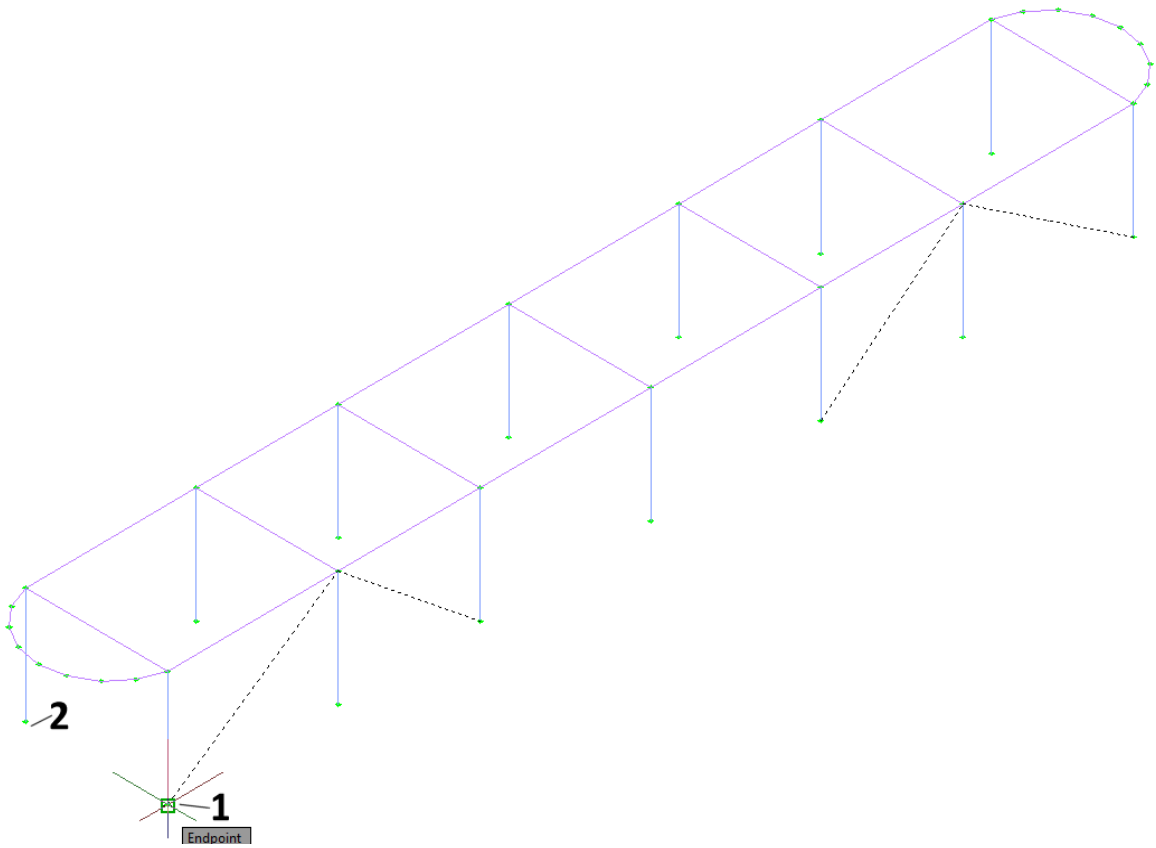

Step #26. View and Save your model: Press the icon  3D to display the 3D solid view as shown in the following image:

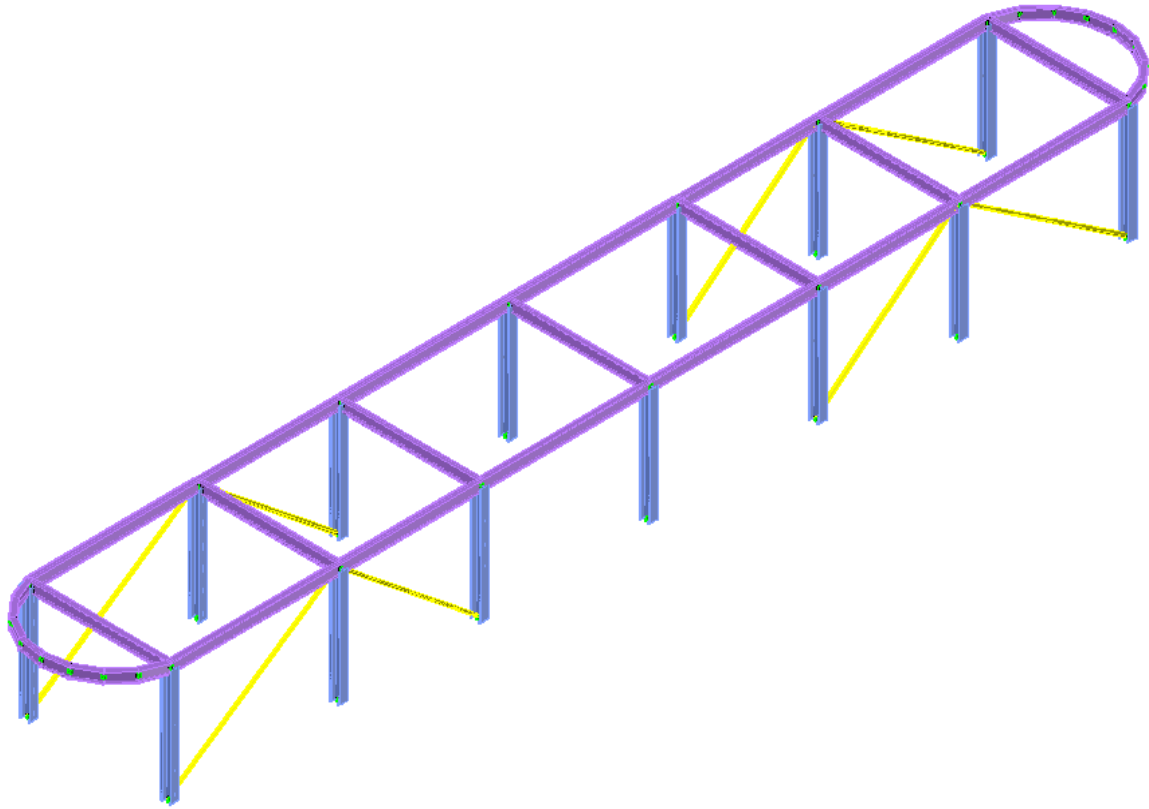

Save your model, using a different file name (Save As...).

Make the entire structure visible by clicking on the icon  All .

Click on the icon  Frame to switch back to the wireframe view.

3.8. Create girders

Step #27. Split the beam members at the top level: Clicking on the  Higher Level icon move to level 3. The current level is displayed at the top caption of AutoCAD:

GTS CAD Modeler | M KN DEG CEN SEC | Level: 3

Click on the icon  Split and click on the members A and B as shown at the following image, and then press <ENTER>.

In order to define Distance for splitting the member or number of parts (negative number), enter -8 , so that the beams A and B will be split into 8 equal parts.

Click again on the icon  Split and click on the members C and D as shown at the following image, and then press <ENTER>.

In order to define Distance for splitting the member or number of parts (negative number), enter -4 , so that the beams C and D will be split into 4 equal parts.

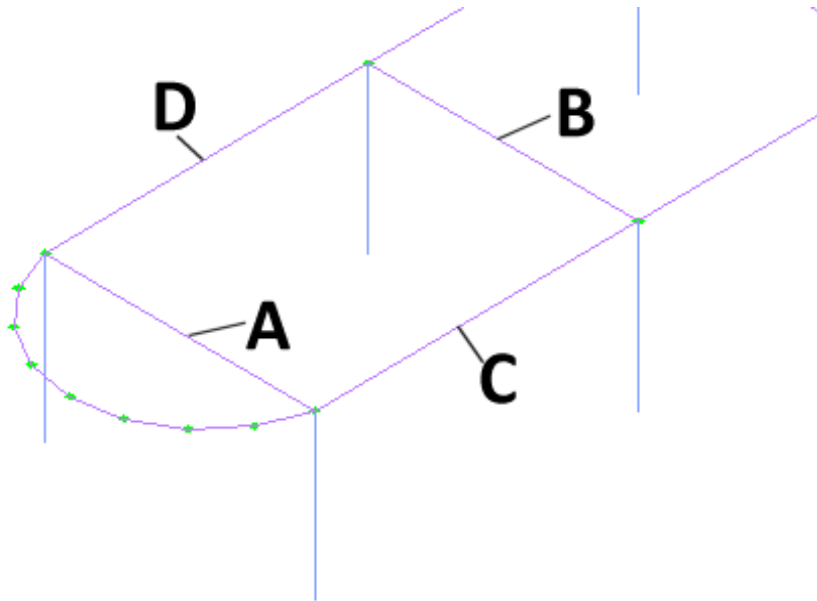

Step #28. Place girder members at the top level: Click on the icon  **Generate** and click on joint located at the point 1 of the following image.

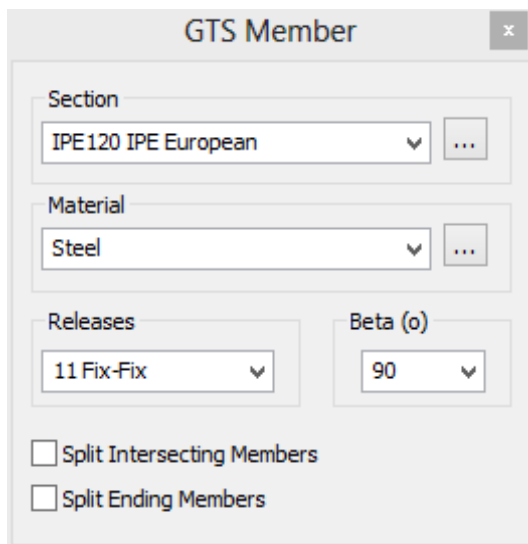

Select *IPE120* as the cross section and make sure that Material is set to *Steel*, Releases to *Fix-Fix* and Beta angle is *90*.

Click on the joint at point 2 and the girder member is generated.

Having the command still active, click on the joints at points 3 and 4 and another girder member is generated.

Continue by clicking on joints at points 5 and 6 and another girder member is generated.

Continue by clicking on joints at points 7 and 8 and another girder member is generated.

Continue by clicking on joints at points 9 and 10 and another girder member is generated.

Continue by clicking on joints at points 11 and 12 and another girder member is generated.

Continue by clicking on joints at points 13 and 14 and another girder member is generated.

Click on the joint located at point 15 and check the option Split Intersecting Members, so that common joints will be created along the previously created X-direction girders.

Click on joint at point 16 and the girder member is generated. Existing girders are split.

Click on the joint located at point 17 and check the option Split Intersecting Members.

Click on the joint at point 18 and the girder member is generated. Existing girders are split.

Click on the joint located at point 19 and check the option Split Intersecting Members.

Click on the joint at point 20 and the girder member is generated. Existing girders are split.

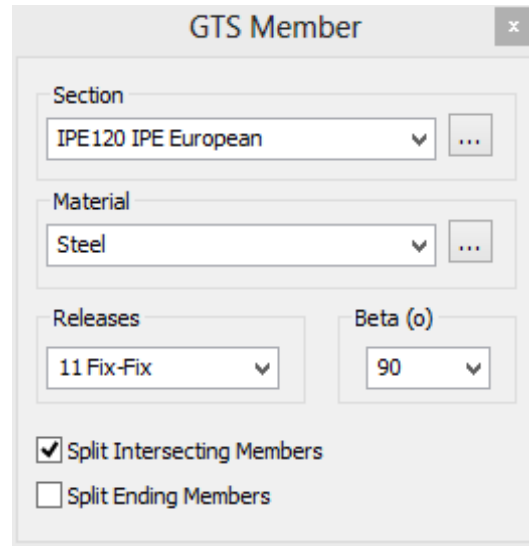

The image shows a software dialog box titled "GTS Member". It contains several configuration options:

- Section:** A dropdown menu showing "IPE 120 IPE European" with a small "..." button to its right.
- Material:** A dropdown menu showing "Steel" with a small "..." button to its right.
- Releases:** A dropdown menu showing "11 Fix-Fix" with a small "v" icon to its right.
- Beta (o):** A dropdown menu showing "90" with a small "v" icon to its right.
- Options:** Two checkboxes are present: "Split Intersecting Members" (which is checked) and "Split Ending Members" (which is unchecked).

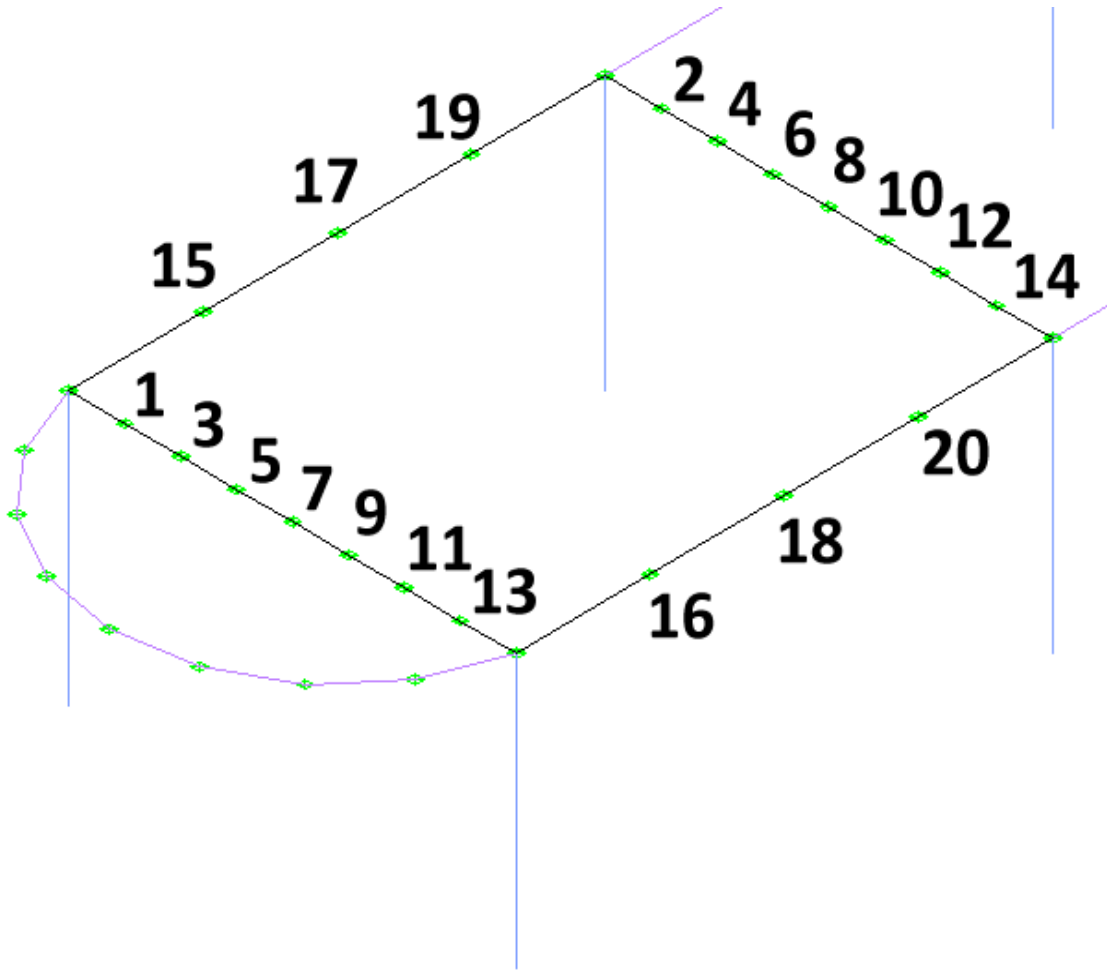

Press ESC to terminate the Generate Beam Command.

Step #29. Add eccentricities to the Girders: Press the icon  3D to display the 3D solid view:

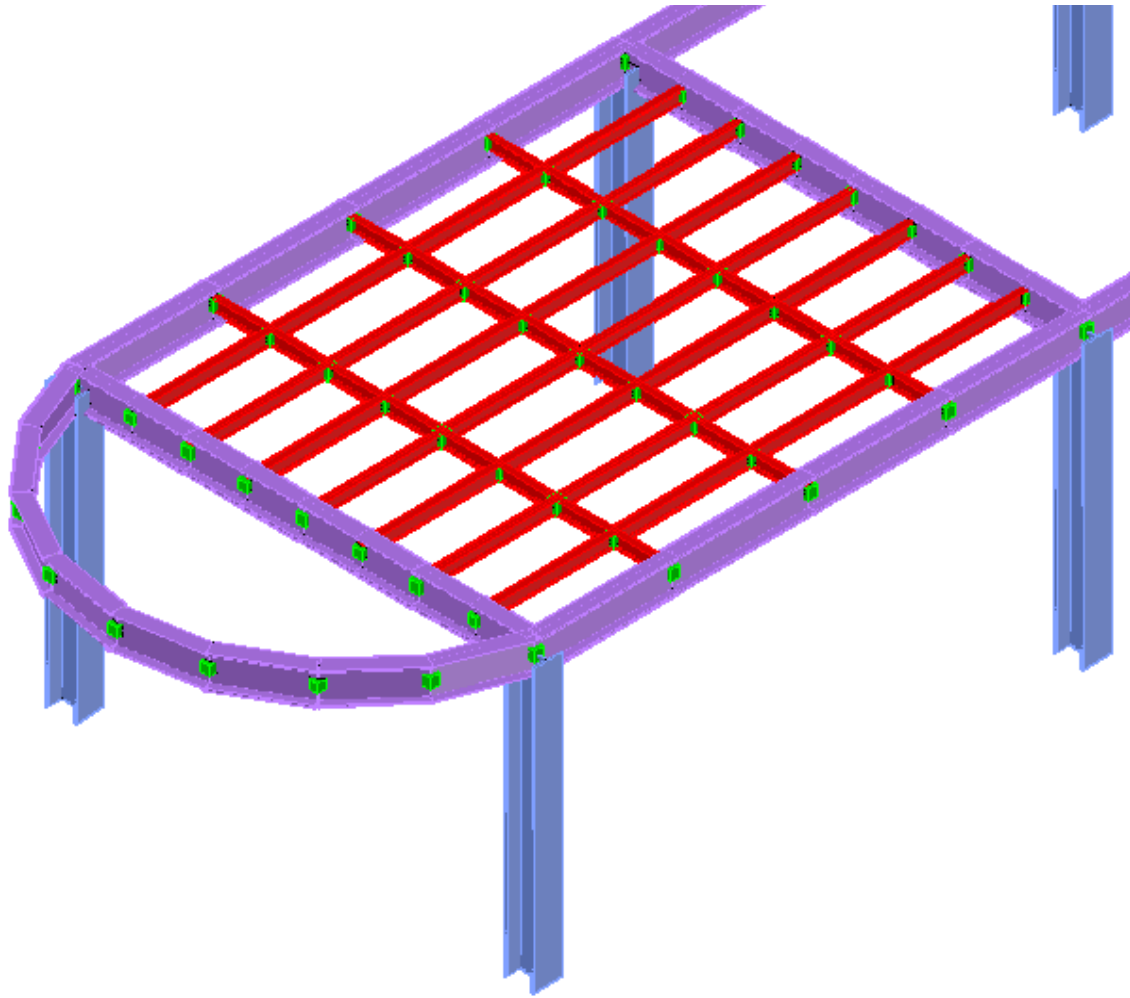

Click on the Top Icon on AutoCAD's View Cube to switch to the top view in order to be able to select girder members easily.

Click on the icon  **Change** and when asked to Select objects: click on the 2 Points of the following image, to select all girder members, and press <ENTER>.

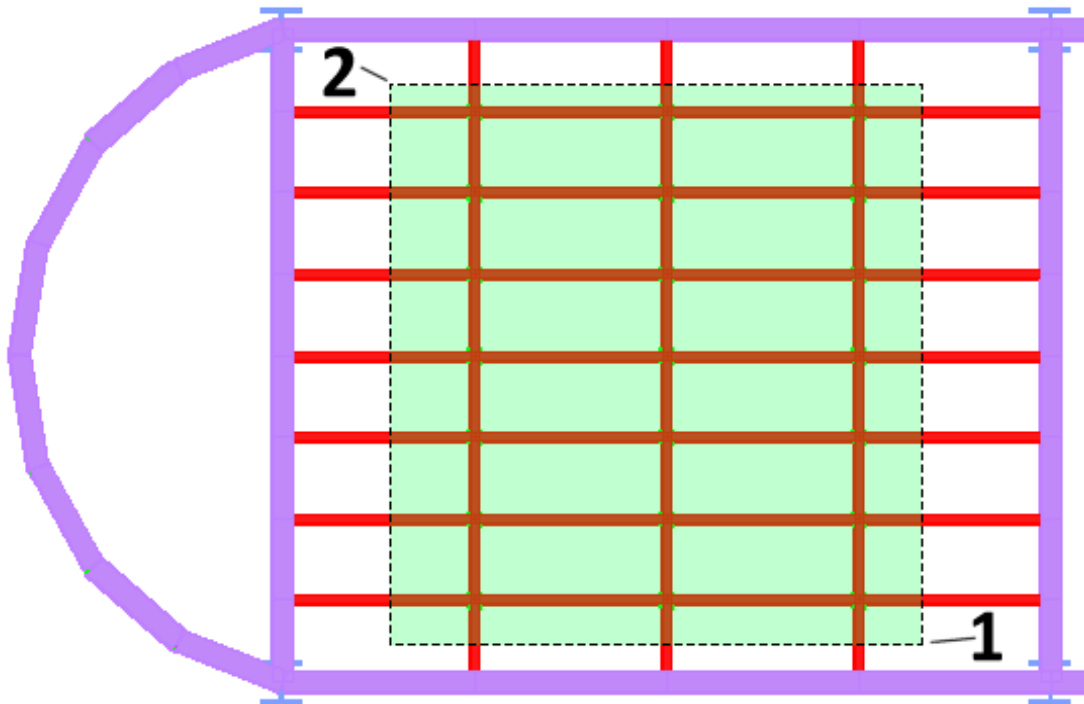

The *Member Properties [Multiple Selection]* form is displayed so you may now specify member eccentricities.

End Sizes OR Member Eccentricities (Offsets)			
	Start		End
Sizes :	<input type="text" value="0"/>		<input type="text" value="0"/>
X :	<input type="text" value="0"/>	X :	<input type="text" value="0"/>
Y :	<input type="text" value="0"/>	Y :	<input type="text" value="0"/>
Z :	<input type="text" value="0.25"/>	Z :	<input type="text" value="0.25"/>

Enter 0.25 for the Z Starting Eccentricity and 0.25 as the Z Ending Eccentricity.

Press OK.

Now the deformable axis of the girder members has been moved 0.25m up in the Z direction.

Switch back to the isometric view by clicking on the House icon on AutoCAD's view Cube to see the result. The girder members now sit on the upper flange of the beam members.

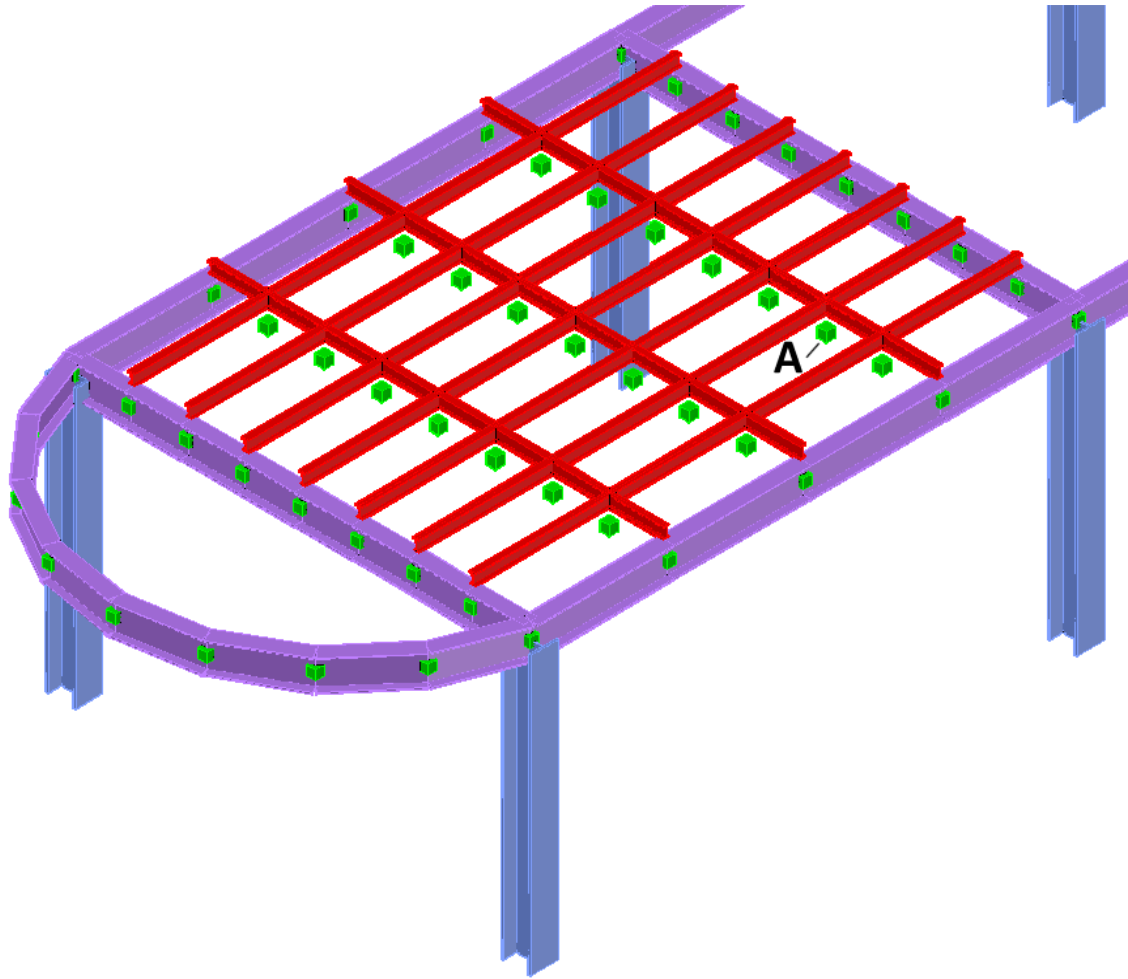

3.9. Create an opening

Step #30. Delete a joint to create an opening: Select the Joint Located in Point A of the image above and press the DEL key.

Warning: All structural entities (members, elements, etc) connected to this Joint will also be deleted? (Yes/No) appears and continue by pressing Y and <ENTER>.

The Joint is deleted together with all members connected to the joint.

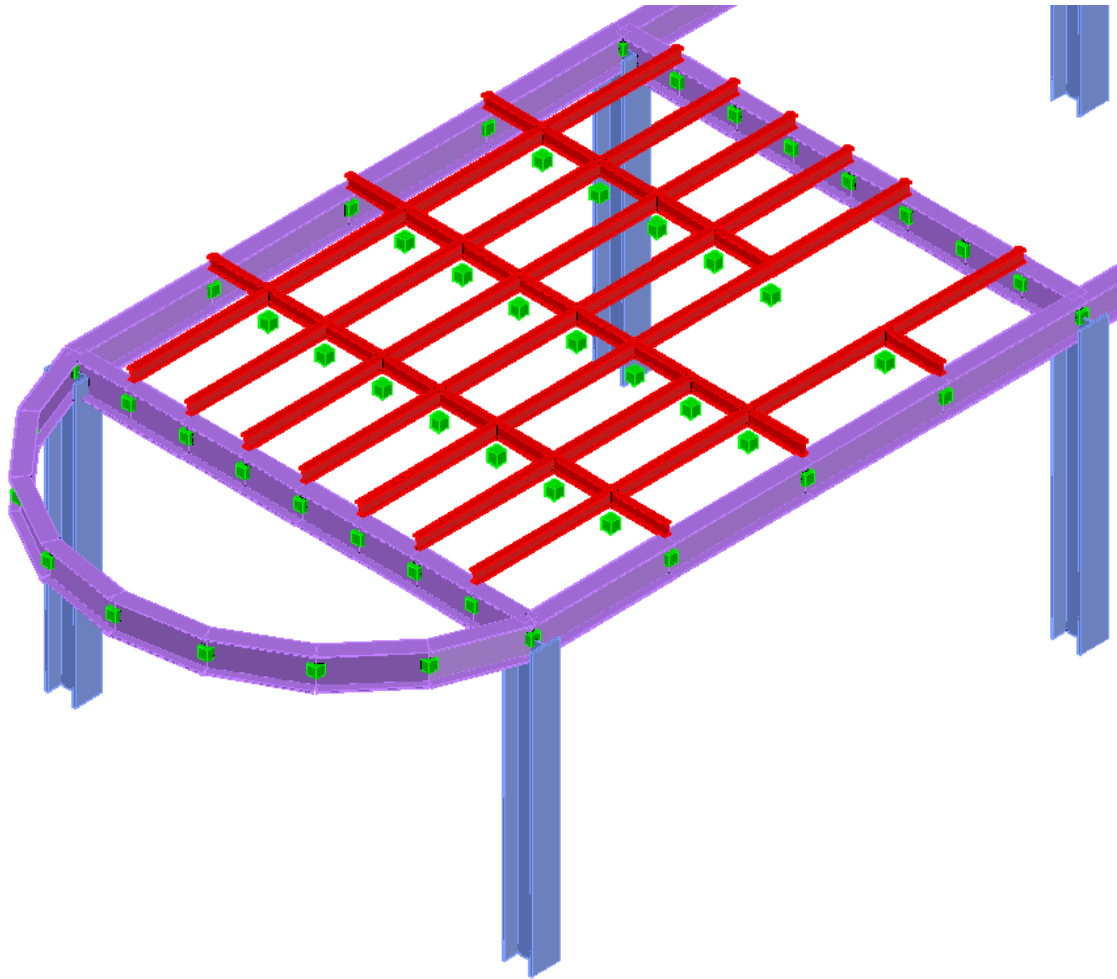

3.10. Create Supports

Step #31. Support the joints at the base of the model:

Make the entire structure visible by clicking on the icon  All and press Z and E (Zoom Extents).

Switch to the FRONT View, by clicking on Front on AutoCAD's view cube.

Click on the icon  Support and select the window by clicking at points 1 and 2 in the following image. All the bottom joints are selected and press OK to finish the selection.

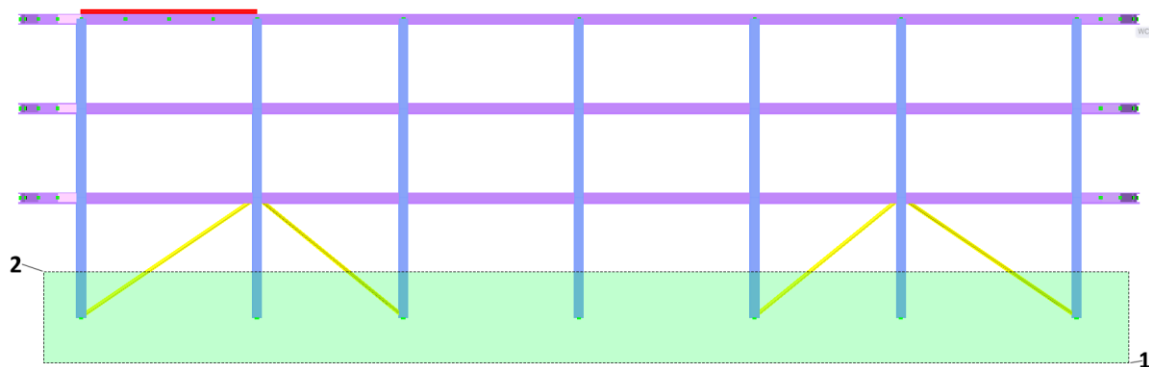

Restraints & Spring values

Quick Selection : Pin

Restraint	Spring	Restraint	Spring
<input checked="" type="checkbox"/> Fx	<input type="text"/>	<input type="checkbox"/> Mx	<input type="text"/>
<input checked="" type="checkbox"/> Fy	<input type="text"/>	<input type="checkbox"/> My	<input type="text"/>
<input checked="" type="checkbox"/> Fz	<input type="text"/>	<input type="checkbox"/> Mz	<input type="text"/>

The Joint Properties [Multiple Selection] form appears.

Select Pin using Quick Selection, and Fx, Fy and Fz are automatically checked.

Press OK.

All the bottom joints are now pinned and have an orange color instead of green to indicate that they are supported.

3.11. Check the model

Step #32. Check for duplicate joints: In order to check for joints having the same coordinates, click on the icon  **Locate Duplicates** under the Joints panel.

For the Merge Accuracy <0.001000>, just press <ENTER> to accept the default value.

The Merge Joints form appears where you can see the list of joints having the same coordinates. Make sure that Merge option is checked for all pairs and press OK.

Merge Joints

List

Joint	Duplicate	Merge
8	25	<input checked="" type="checkbox"/>
16	17	<input checked="" type="checkbox"/>

Select All

Unselect All

OK

Cancel

By entering the same command again, for the 2nd time, you should get the notification that *0 duplicate joints found*.

Step #33. Check for floating joints: In order to check for joints not connected to the model, click on the icon  **Locate Floatings** under the Joints panel. If your model was created as described so far, you should get a notification *0 floating joints found*.

3.12. Define Groups

Step #34. Create Group Names: It is optional to define Groups in your model but it is strongly recommended to do so since it will be easier to control the display and selection for parts of your structure.

Click on the icon  **List** in the Groups panel and the Group dialog appears.

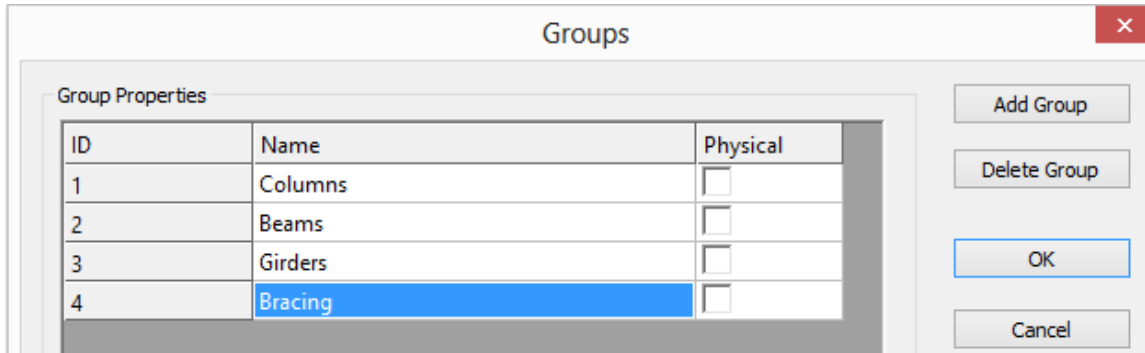

Press the *Add Group* button and enter `Columns` as *Name* of the group.

Press the *Add Group* button and enter `Beams` as *Name* of the group.

Press the *Add Group* button and enter `Girders` as *Name* of the group.

Press the *Add Group* button and enter `Bracing` as *Name* of the group.

Press OK to close the form.

Step #35. Add Columns to their Group.

Click on the icon  **Colors** and make only profiles HE320B visible by unchecking all others.

Sections	Color	Visible
HE320B	161	<input checked="" type="checkbox"/>
IPE330	191	<input type="checkbox"/>
IPE120	1	<input type="checkbox"/>
60x60x5	50	<input type="checkbox"/>

Press OK.

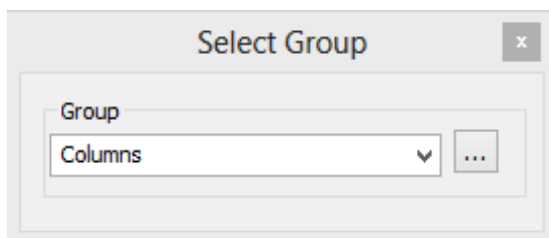

Click on the icon  **+Members** in the Groups panel and make sure that the Group `Columns` is selected as the active group.

Select everything on the screen in a full window and press the Enter key.

To verify that the group is applied correctly, you can double click on a column and in the Member Properties form, you will be able to see its Group definition.

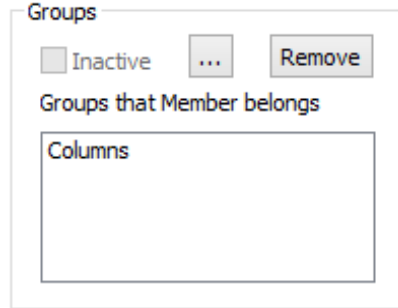



Step #36. Add Beams to their Group:

Click on the icon  Colors and make only profiles IPE330 visible by unchecking all others.

Sections	Color	Visible
HE320B	161	<input type="checkbox"/>
IPE330	191	<input checked="" type="checkbox"/>
IPE120	1	<input type="checkbox"/>
60x60x5	50	<input type="checkbox"/>

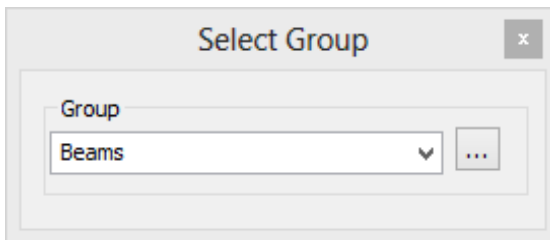
Press OK.



Click on the icon  +Members and make sure that the Group Beams is selected as the active group.

Select everything on the screen. in a full window. and press the Enter key.

Step #37. Add Girders to their Group:

Click on the icon  Colors and make only profiles IPE120 visible by unchecking all others.

Sections	Color	Visible
HE320B	161	<input type="checkbox"/>
IPE330	191	<input type="checkbox"/>
IPE120	1	<input checked="" type="checkbox"/>
60x60x5	50	<input type="checkbox"/>

Press OK.

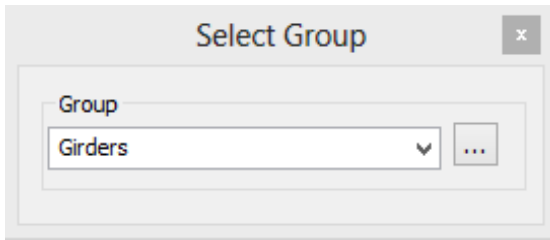

Click on the icon  +Members and make sure that the Group Girders is selected as the active group.

Select everything on the screen. in a full window. and press the Enter key.

Step #38. Add Bracing to their Group:

Click on the icon  Colors and make only profiles 60x60x5 to be visible by unchecking all others.

Sections	Color	Visible
HE320B	161	<input type="checkbox"/>
IPE330	191	<input type="checkbox"/>
IPE120	1	<input type="checkbox"/>
60x60x5	50	<input checked="" type="checkbox"/>

Press OK.

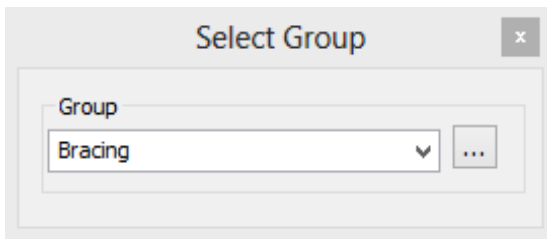

Click on the icon  +Members and make sure that the Group Bracing is selected as the active group.

Select everything on the screen. in a full window. and press the Enter key.

3.13. Define Loads

Step #39. Define Self Weight: Click on the icon  Self Weight and the Self Weight dialog appears. Enter:

- SW as Name
- Self Weight as the Load Description
- Negative Z as the Global Axis for the direction of the load
- 1.0 as Factor
- Check Include finite elements

and press Create New to create the new loading and then Exit to close the dialog.

Self Weight or Dead Loads ✕

Load Information

Load ID : Create New

Name : Save / Modify

Load Description : Delete

Loads applied parallel to this Global Axis

Negative Y Positive Y
 Negative Z Positive Z
 Negative X Positive X

Factor : Include Finite Elements

Exit

Step #40. Define Load Cases: Click on the icon  **Load Cases** and the Load dialog appears.

Enter:

- *LL* as Name
- *Live Load* as the Load Description

and press Create New.

Load Case ✕

Load Case Information

Name (up to 8 chars) : Create New

Description : Save / Modify

Load Cases List : Delete

Enter:

- *PL* as Name
- *Point Load* as the Load Description

and press Create New.

Load Case ✕

Load Case Information

Name (up to 8 chars) : Create New

Description : Save / Modify

Load Cases List : Delete

Press Exit to close the dialog.

Step #41. Apply Live Loads: Live Loads will be applied only to Beam Members, therefore click on the icon  Colors . Select the 2nd Tab in order to colorize members by their group and make only the Group Beams visible and press OK.

Sections **Groups**

Categories

Groups	Color	Visible
Columns	161	<input type="checkbox"/>
Beams	191	<input checked="" type="checkbox"/>
Girders	1	<input type="checkbox"/>
Bracing	50	<input type="checkbox"/>
UnGrouped data	7	<input checked="" type="checkbox"/>

Click on the icon  Member Load , under Loads ▾ panel. Using a full window, select all entities that appear on screen and press <ENTER> to finish with the selection.

The Member Properties [Multiple Selection] form appears having the tab “Member Loads” active.

Click on LL at the “Empty Load Cases” list box and then enter

- *Uniform* as the Load Distribution
- *Force* as Load Type
- *Z Global* as Direction
- -5 as V1
- Fractional as Location
- 0.0 as L1
- 1.0 as L2

Press Create New and the number 125 appears next to the \$ symbol the Empty Load Cases list box. This is a notification that 125 members are loaded in Load Case LL.

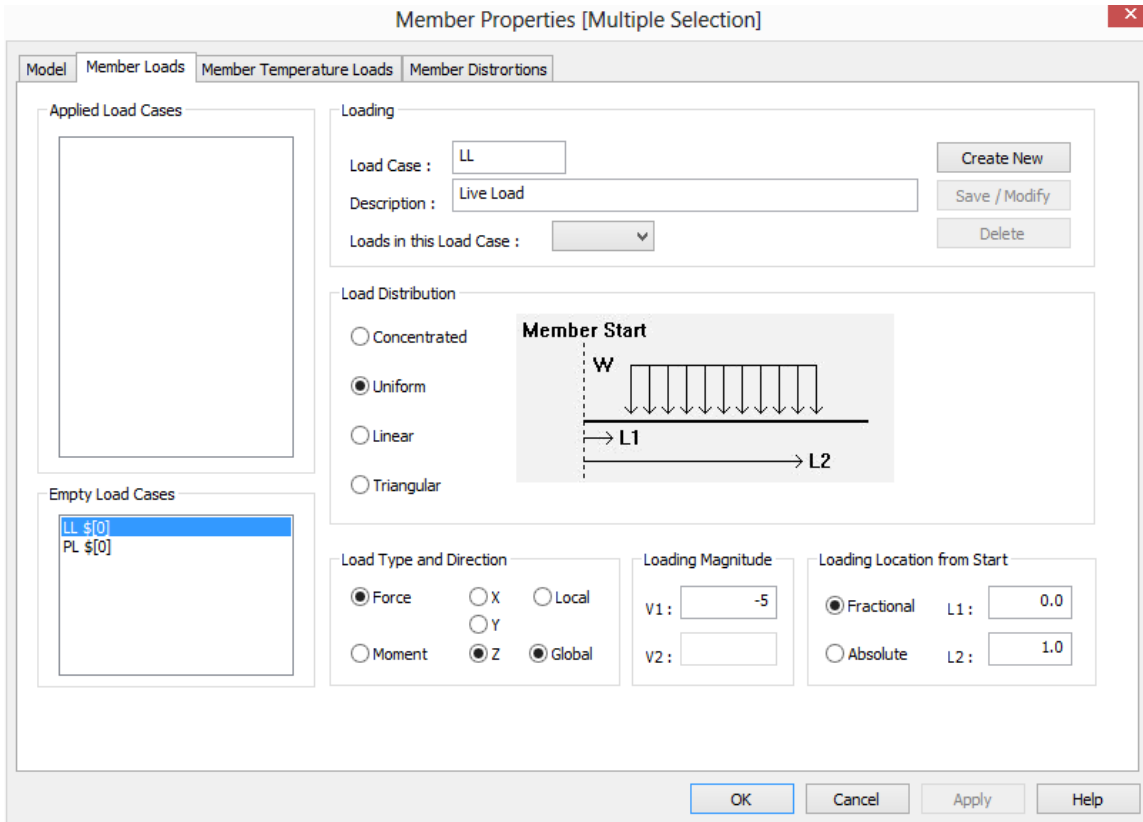

Press OK to close the dialog.

By double clicking on one beam and then selecting the Member Loads tab and clicking on LL at the Applied Load Cases List Box, you will be able to view and edit the existing loading values of the specific beam.

Click on the icon  Colors, select the 1st Tab in order to colorize members by their section and then select everything to be visible and press OK.

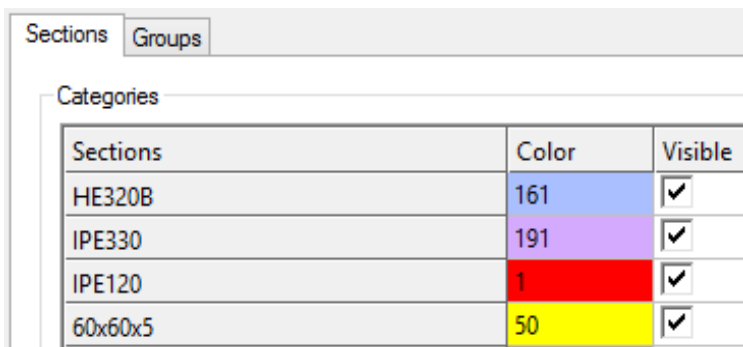

Step #42. View Live Loads: Click at the icon  Frame to switch to the wireframe view.

In the menu bar, click on GTS Display>Member Loads and the Display Loads form appears:

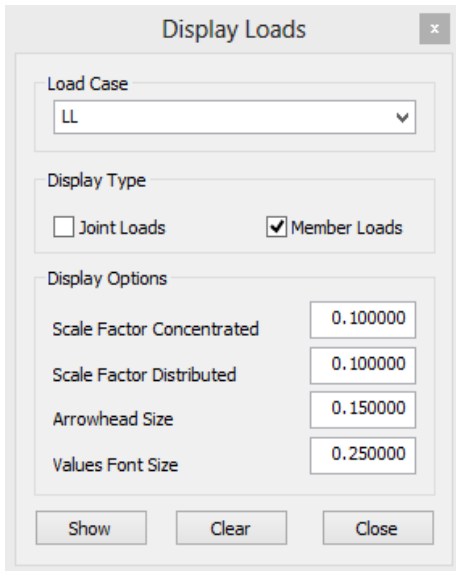

Select LL as the Load case and leave the other display options at their default values.

Press Show and the loading arrows are displayed.

Click on Clear when you are done and Close to exit from the dialog.

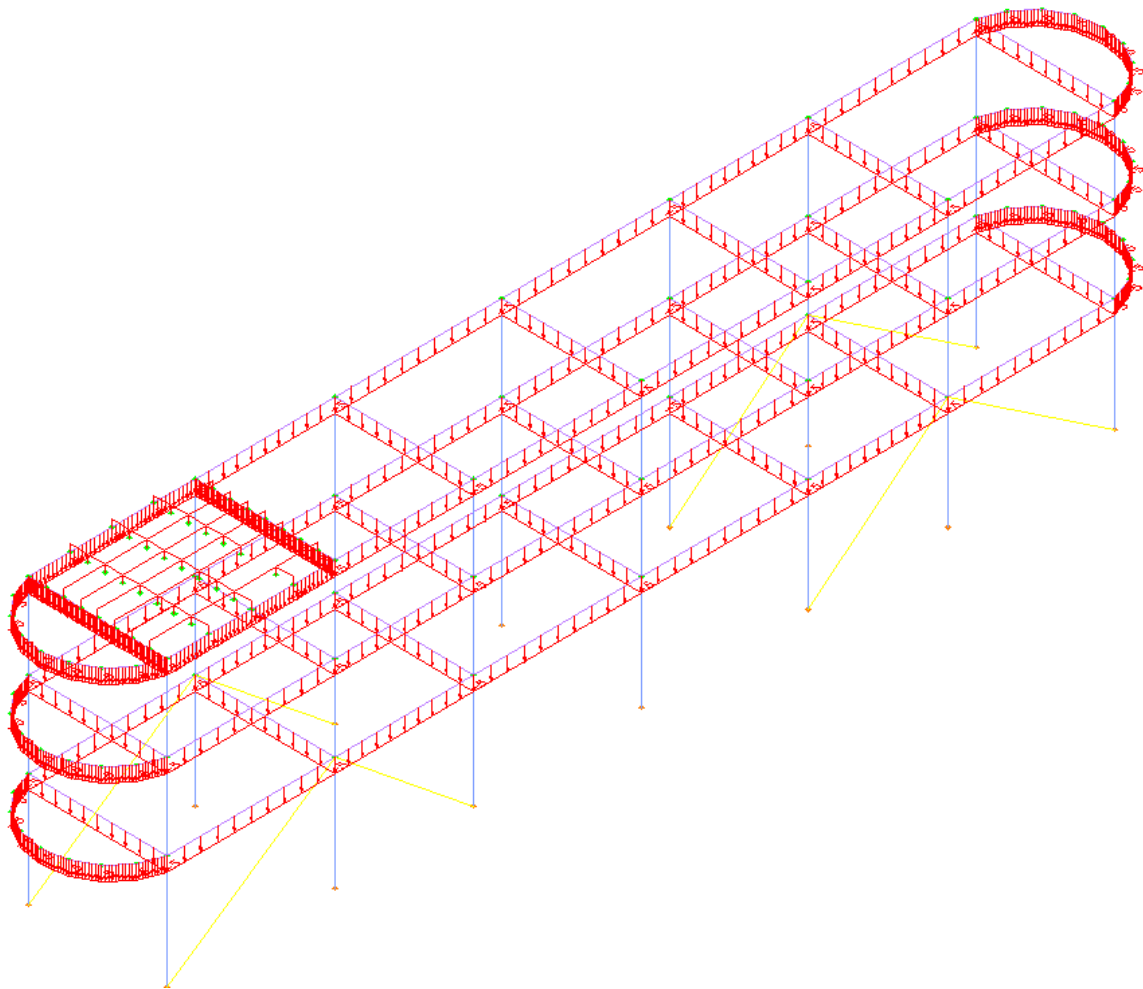

Click at the icon  3D to display the 3D solid view.

Step #43. Apply Joint Load: A Joint load will be applied to the Joint located at Point A of the following image.

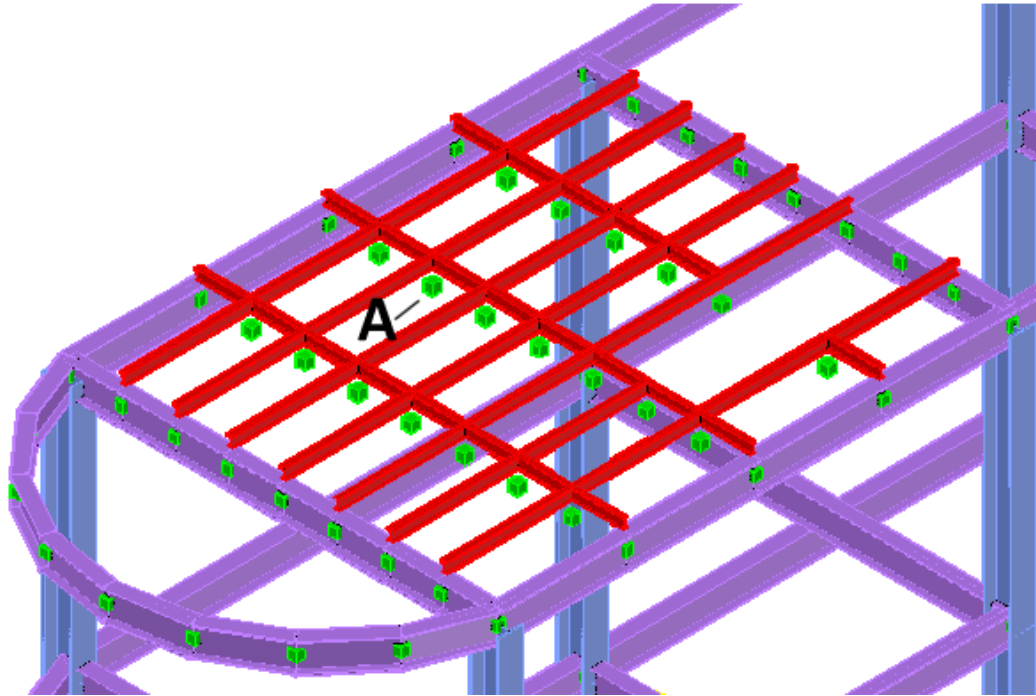

Zoom closer to the specific point using AutoCAD's zooming functions.

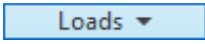
Click on the icon  **Joint Load** under the  panel, click on the joint at A and press <ENTER> to finish with the selection.

The Joint Properties [Multiple Selection] form appears having the tab "Joint Loads" active.

Click on PL in the "Empty Load Cases" list box and then enter -3 for Force Z as shown in the Joint Properties form on the next page.

Press Create New, and the number 1 appears next to the \$ symbol in the Load Cases list box. This is a notification that 1 joint is loaded under the Load Case PL.

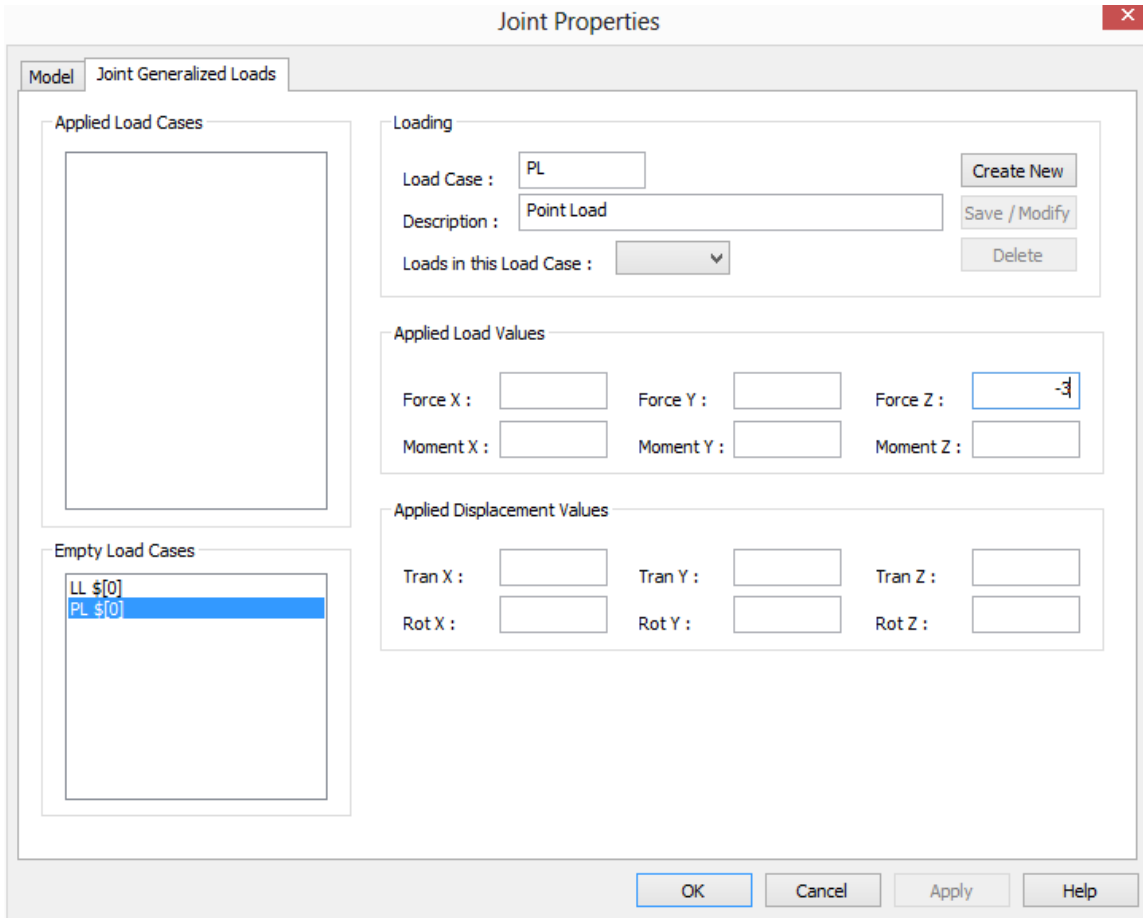

Step #44. View Joint Load: Click at the icon  Frame to switch to wireframe view.

In the menu bar, click on GTS Display>Jont Loads and the Display Loads form appears:

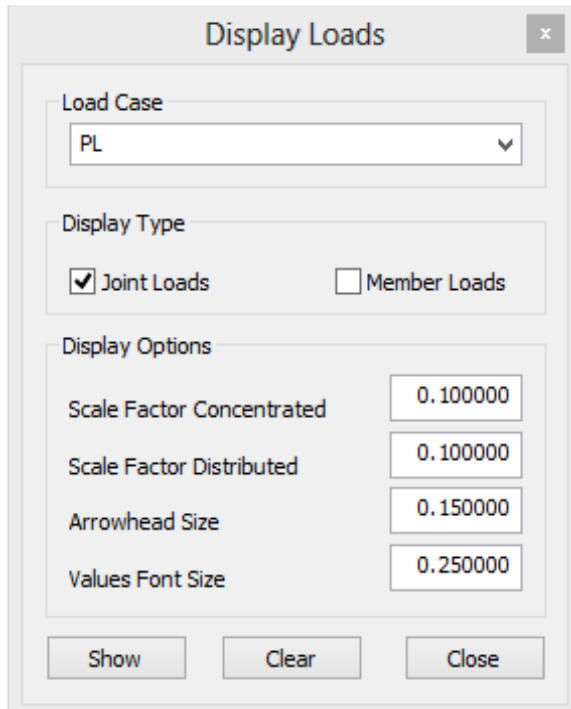



Select PL as the Load case and leave the other display options at their default values.

Press Show and the loading arrows are displayed.

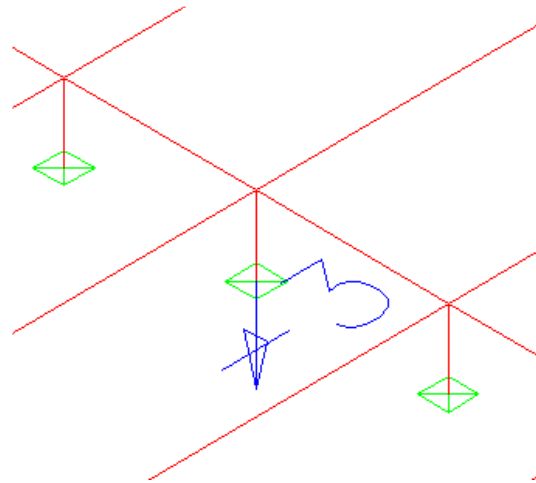
Click on Clear when you are done and Close to exit from the dialog.



Click at the icon  3D to display the 3D solid view.

Step #45. Define Load Combinations: Click on the icon  Load Comb. and the Load Combination dialog appears. Enter:

- CB1 as Name
- Load Combination 1 for the Description of the Load Combination
- Click on SW, Enter 1.35 as the factor and press ADD>>
- Click on LL, Enter 1.5 as the factor and press ADD>>
- Click on PL, Enter 1.5 as the factor and press ADD>>
- Press Store
- Press Done to close the dialog.

New Form Load or Load Combination ✕

Load Information

Name :

Description :

Type

Load Combination

Form Load

Combine

SW (Self Weight)
LL (Live Load)
PL (Point Load)
CB1 (Load Combination 1) 'SW' 1.35000 'LL' 1.50000 'PL' 1.50000

ADD >>

Factor :

SW 1.35000
LL 1.50000
PL 1.50000

Delete Item

STORE V

All Formed Loads or Combinations

CB1 (Load Combination 1) 'SW' 1.35000 'LL' 1.50000 'PL' 1.50000

Edit

Delete

Done

3.14. GT STRUDL Input File

Step #46. Create GTI: Click on the icon **Create GTI** and the Create GT STRUDL Input file dialog appears. Keep the default GTI filename, check all options except “Read Finite Element Results” as shown in the following image and press OK.

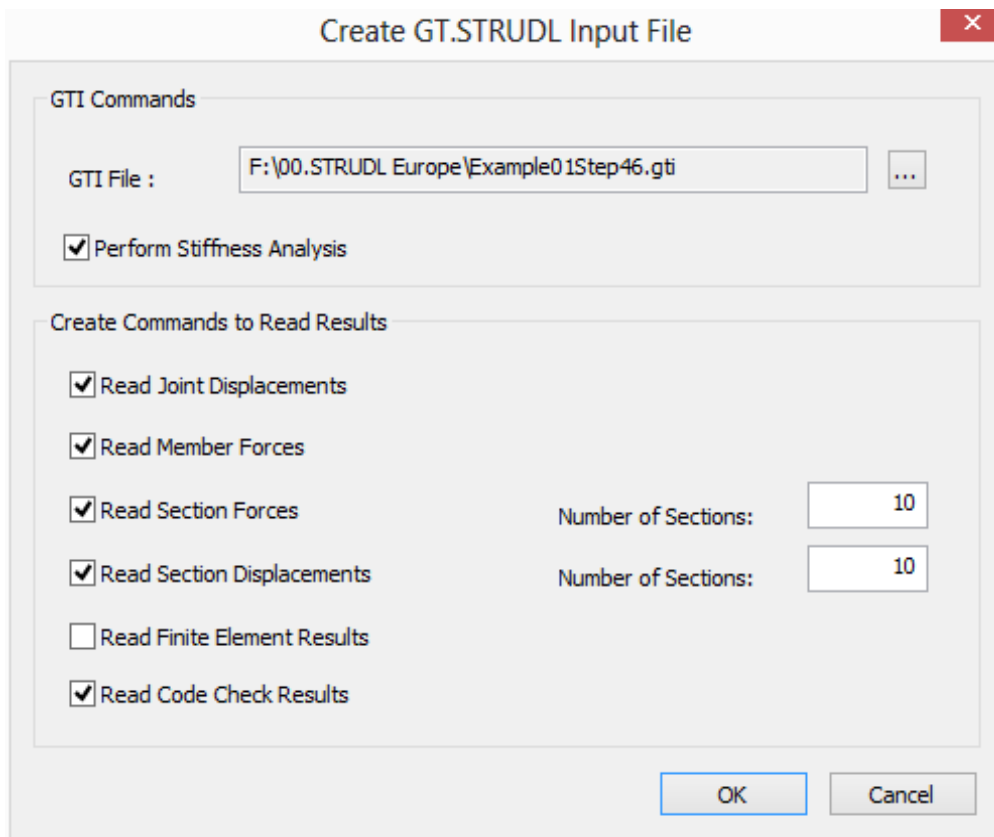

Step #47. View/Edit GTI: Click on the icon  **Edit GTI** and the GTI file created in the previous step will be opened by the system's default text editor.

Step #48. Execute GT STRUDL: Click on the icon  **Execute GT STRUDL** and the GTI file created in the previous step will be sent to GT STRUDL main program that is waiting in the background.

Stiffness analysis is automatically performed and DBX result files are automatically created.

In order to demonstrate the use of the command that reads back design results, add the following commands into GT STRUDL main window (note that the steel design Parameters are incomplete)

```
PARAMETERS
```

```
CODE EC3 ALL MEMBERS
```

```
CHECK ALL MEMBERS AS BEAM
```

```
WRITE REPLACE CODE MEMBERS EXISTING
```

```
The result of the CHECK ALL MEMBERS command shown above is that members 148 149
150 151 152 153 154 155 FAILED CODE CHECKS
```

In addition, you can enter GTMenu to view the model and the results as described in the GTMenu User Guide. The structure is displayed in GTMenu as shown on the next page.

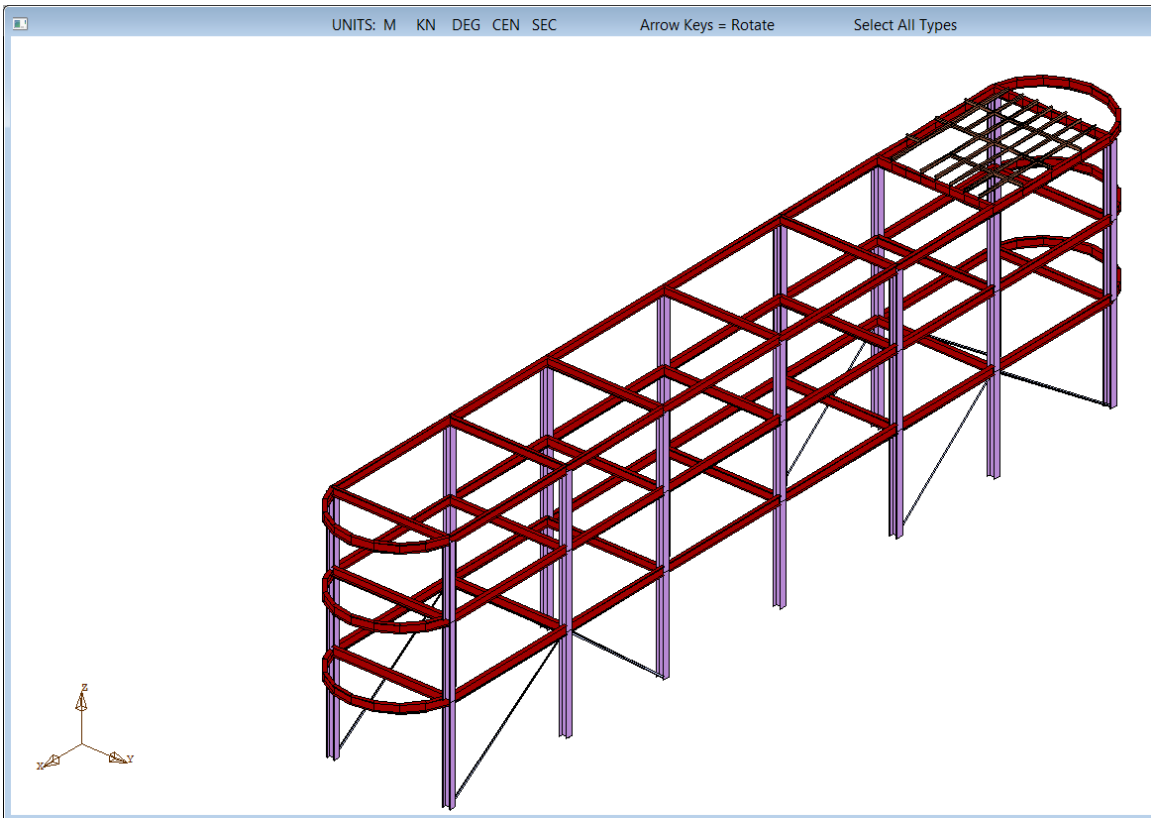

Step #49. Read Results from GT STRUDL: In CAD Modeler, click on the icon  **Read GT STRUDL Results** and the Read GT.STRUDL Results dialog appears. Check all options except “Read Finite Element Results” as shown below and press OK.

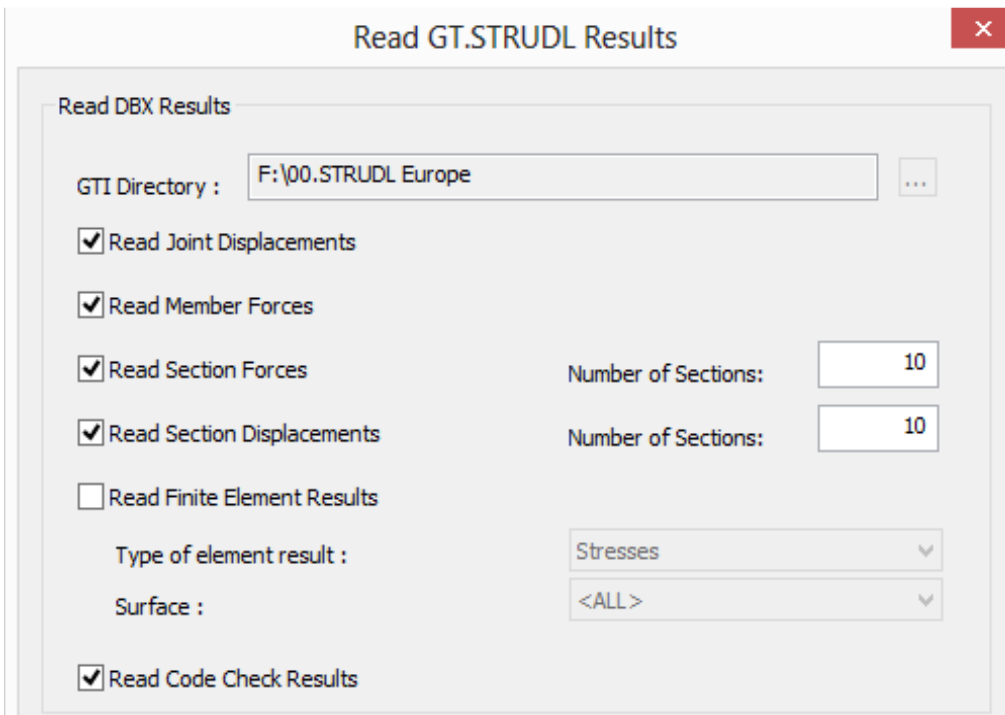

3.15. Display Results

Step #50. Show Displacements: In the menu bar, click on GTS Display>Deformed Structure and then select SW as load Case and press ENTER twice. The deformed structure will be drawn as shown below.

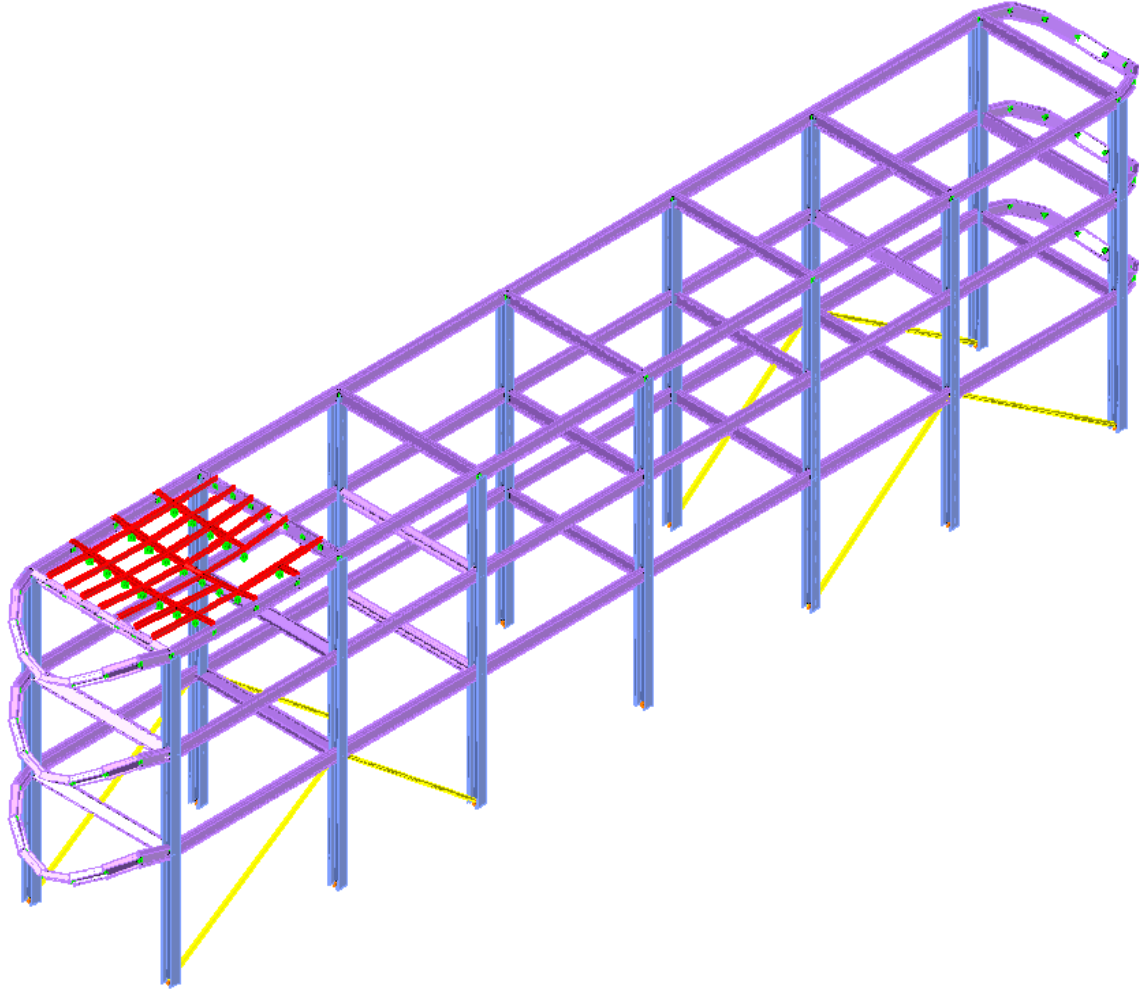

Repeat and select PL as the Load Case and the deformed structure appears as shown in the following image:

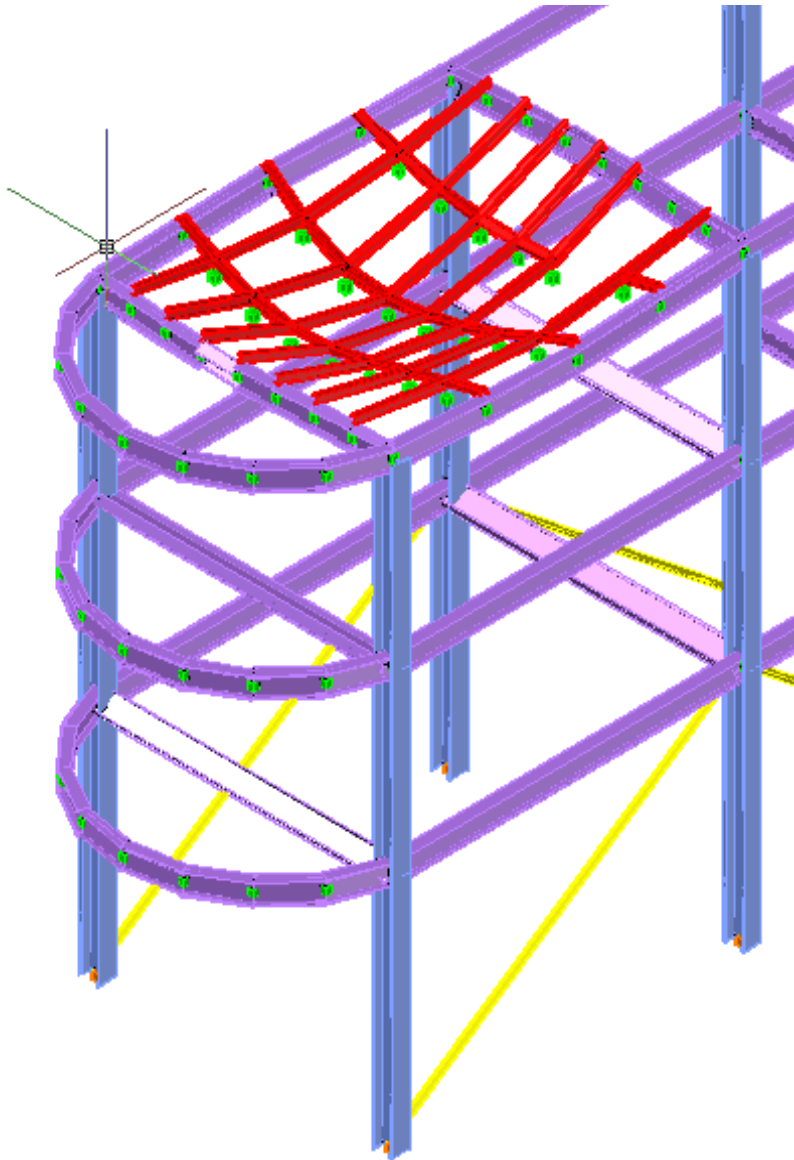

In the menu bar, click on GTS Display>Undeformed Structure to return to the original undeformed position of the model.

Step #51. Show Code Check Results: In the menu bar, click on GTS Display>Member Code Check Results.

The following image is drawn with the bracing members that failed the check (149 to 155) appearing in red and members that passed the check appearing in blue.

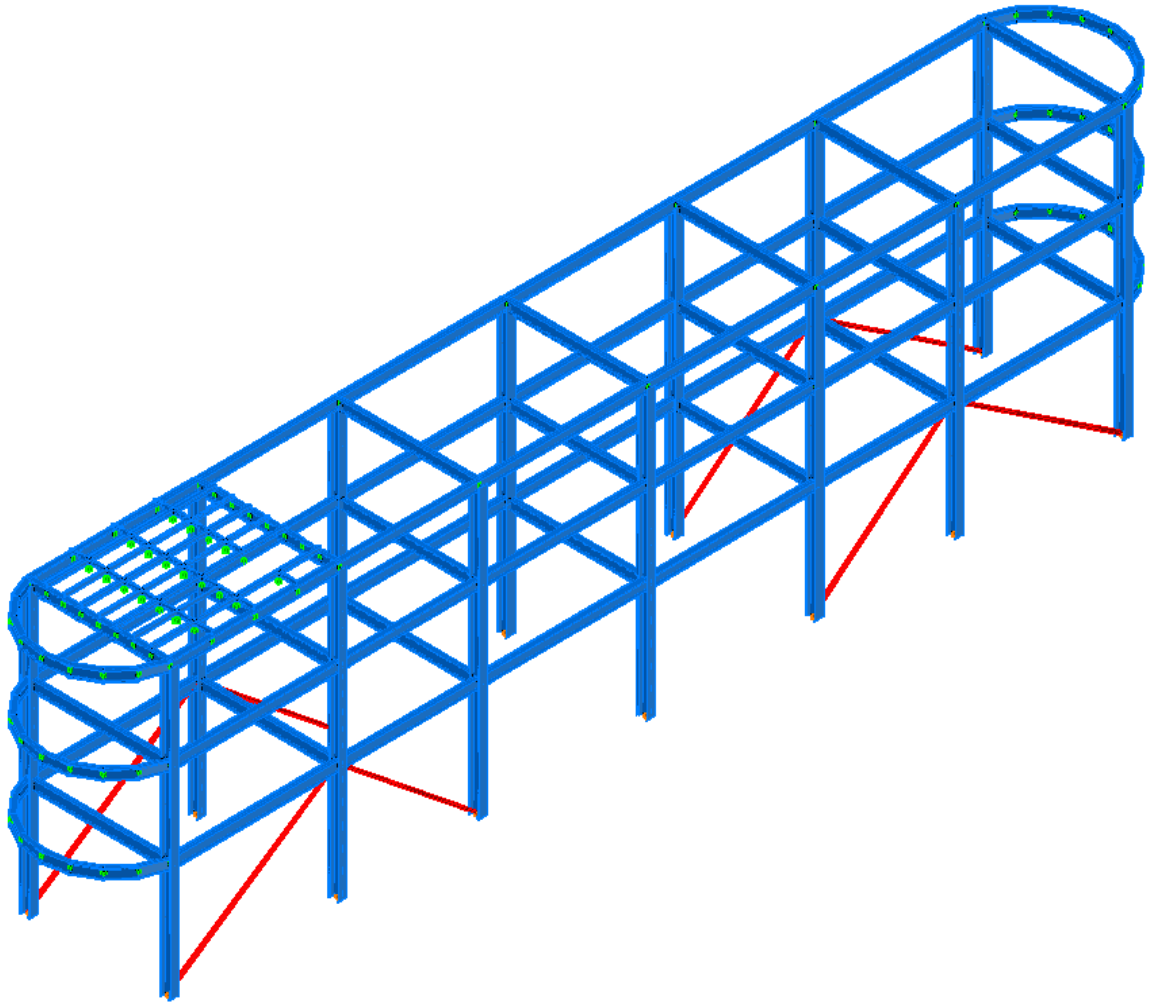

4. Tutorial Example #2

4.1. Introduction

The modeling and analysis of the tank shown below is demonstrated in a step-by-step process using CAD Modeler and GT STRUDL finite element analysis.

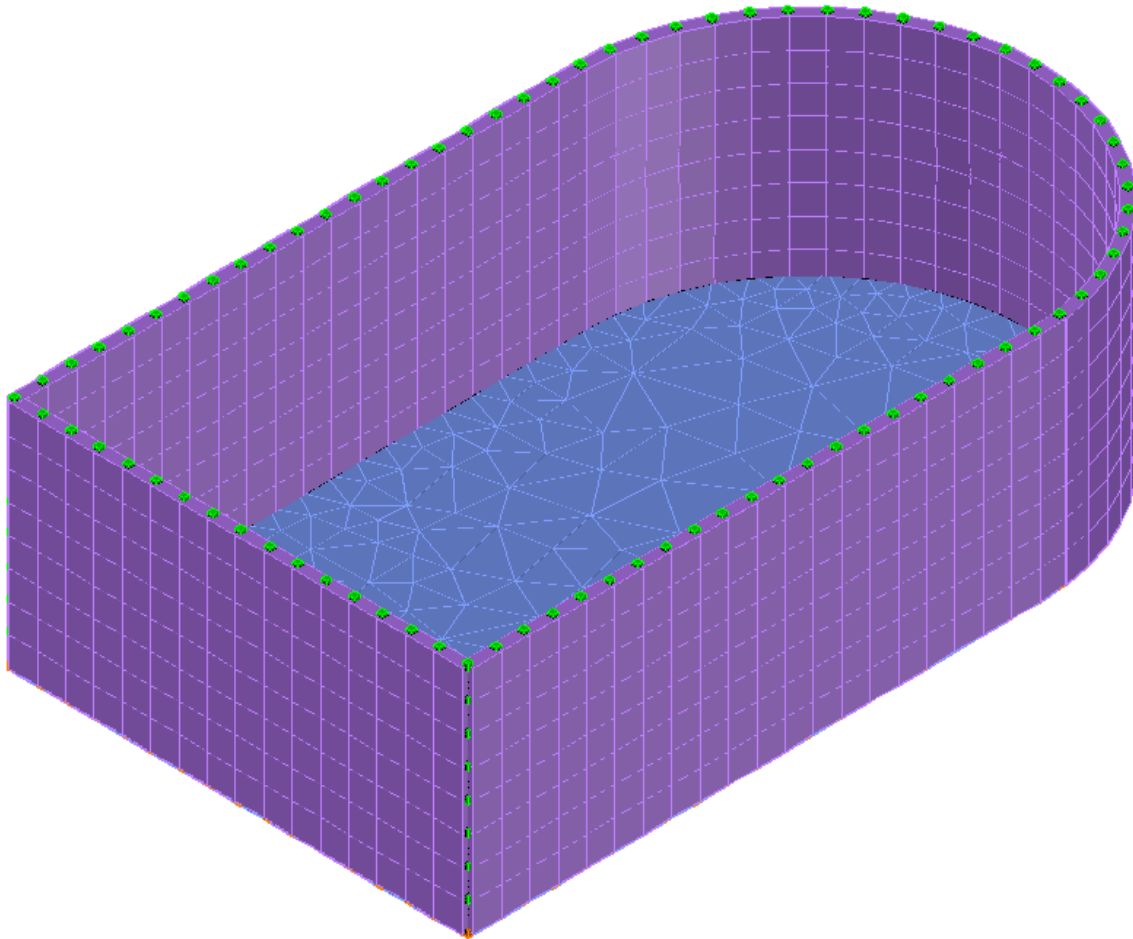

4.2. Open CAD Modeler and start working

Step #52. Launch GT STRUDL by selecting the icon “CAD Modeler” in the Welcome to GT STRUDL dialog shown below. The version of AutoCAD selected during the installation will be automatically launched, together with CAD Modeler’s menus and ribbon bar.

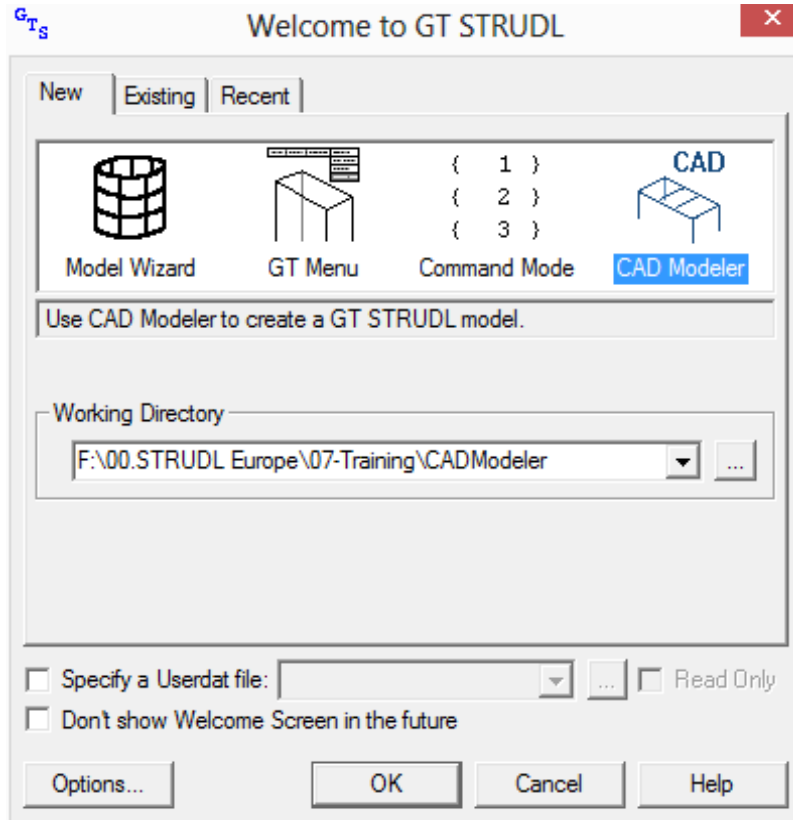

4.3. Define the basic geometry of the model

Step #53. Define the correct Units by pressing the icon  and select *Meters (m)* and *KiloNewtons* in the *Units Form*.

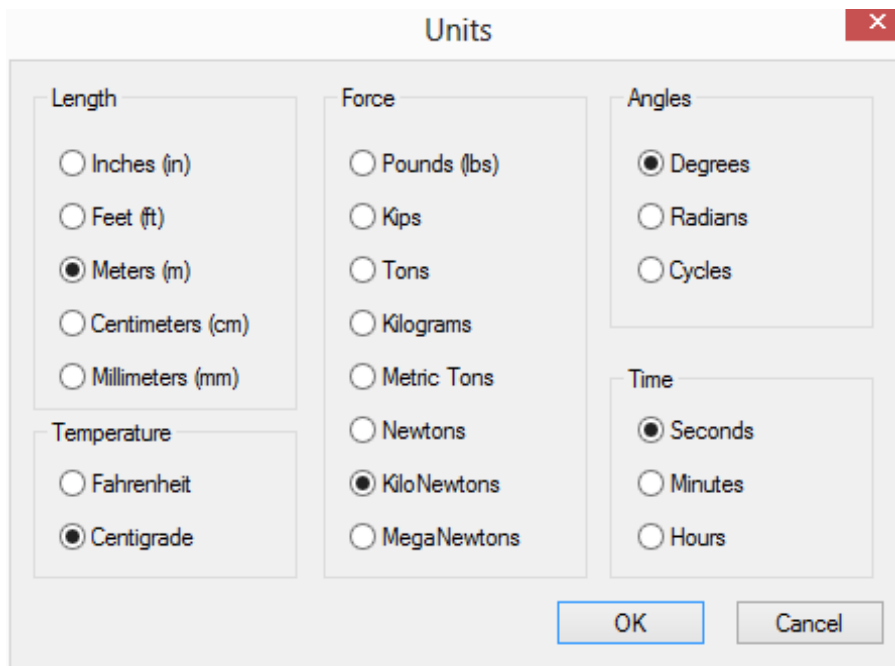

Step #54. Create an AutoCAD Polyline that will describe the outline of the tank. Type the following commands at the command prompt (each command is followed by an <ENTER>):

```
PLINE  
0,0,0  
@10,0  
ARC  
@4,4  
@-4,4  
LINE  
@-10,0  
CLOSE
```

The polyline shown in the picture below is created after entering Zoom and Extents at the command prompt.

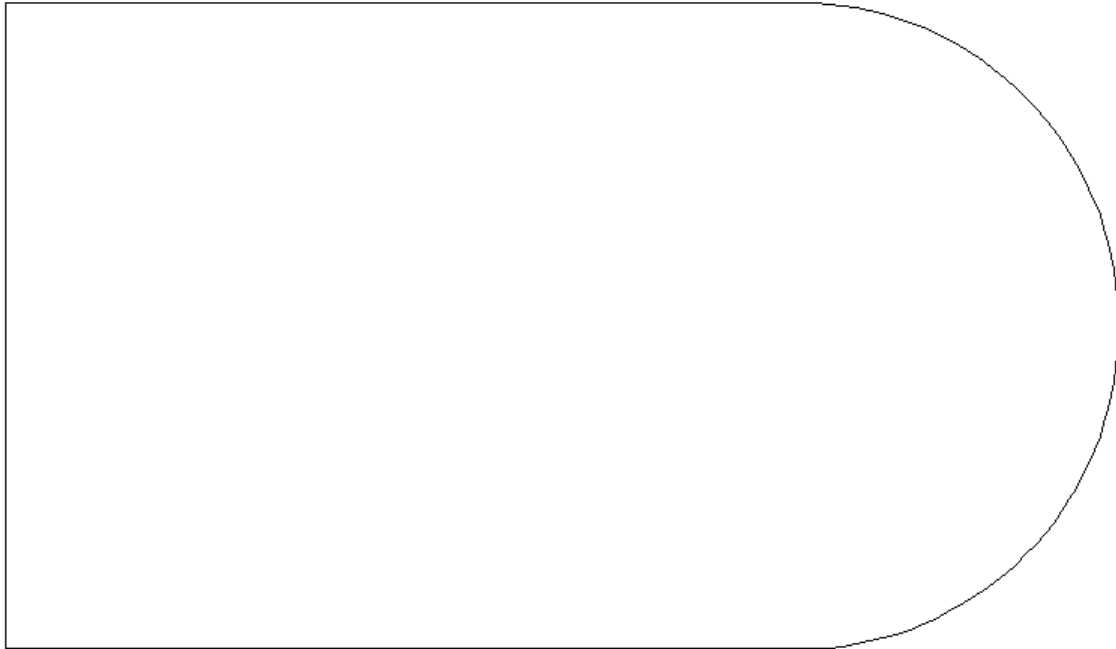

Step #55. Create a Line along the height of the tank: Switch to the isometric view of the structure by pressing the small house icon in AutoCAD's View Cube.



Type the following commands at the command prompt (each command is followed by an <ENTER>):

```
LINE  
0,0,0  
@0,0,4  
<ENTER>
```

The line shown at the picture below is created.

Click on the TOP icon of the AutoCAD's View Cube in order to switch back to floor plan view.

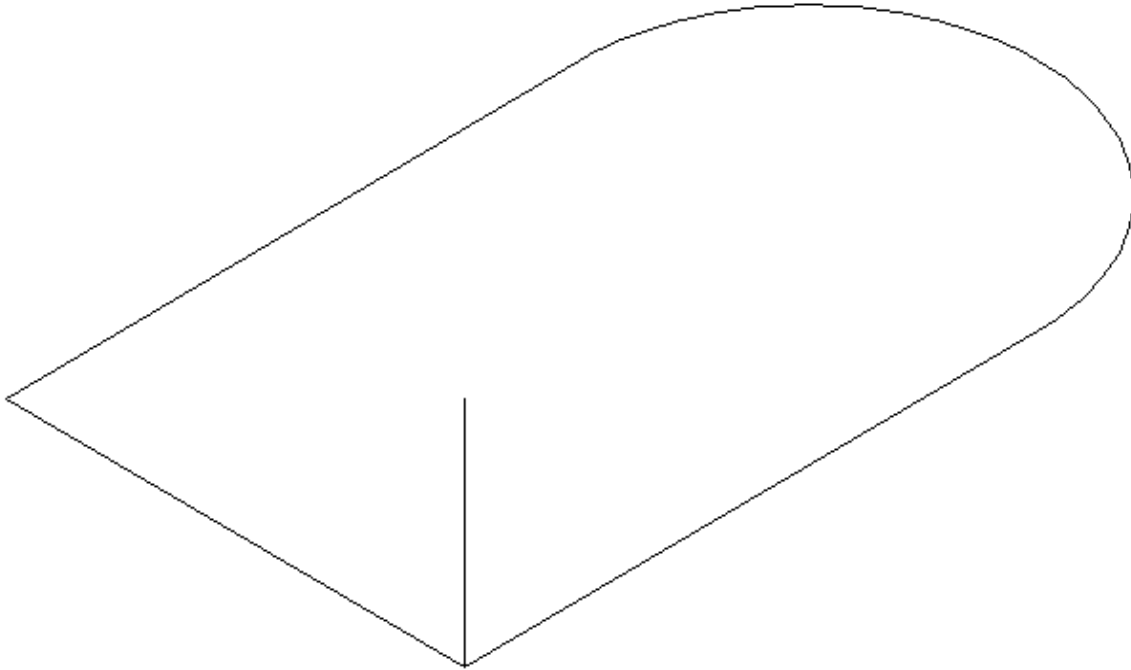

4.4. Create the bottom of the tank

Step #56. Generate the Finite Elements inside the polyline, at the bottom of the Tank: Click on the icon  **2D Area** and when the prompt message *Poly Select Boundary Polyline or Circle* appears, click on the Polyline that you have created in the previous step.

Select Mesh Properties x

Generate

Material: Concrete ...

Element Attributes

Type: SBHT6 Thickness: 0.20

Mesh Geometry

External Boundary: obj-563 ...

Boundary Maximum Edge Size: 0.5

Do not split boundary more than Max

Element Maximum Area: 10.513274

Mesh Quality: High

Internal Boundaries

Add
Remove

MultiA
MultiR

Internal Joints

Add
Remove

Spacing Extrude Direction

Uniform 4 v
 Variable ...
 Defined by Curve, Size: 3.242418

Labeling

More >>

Preview
Clear
Create
Close

The Select Mesh Properties form appears where you have to enter:

- Material : *Concrete*
- Type: *SBHT6*, meaning triangular elements having 6 degrees of freedom per node
- Thickness: *0.2*
- Boundary Maximum Edge Size: *0.5*
- Mesh Quality: *High*

You can press the Preview button to see the finite elements as they will be generated.

Press the Create button to create the finite elements and joints on the bottom of the tank.

Step #57. Turn OFF labeling and view mesh:

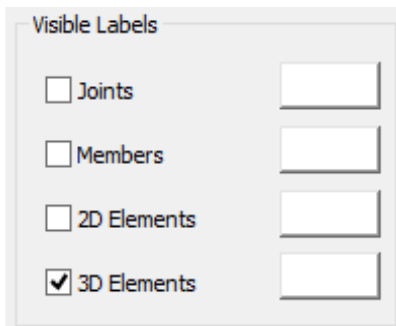

Click on the icon  **Options** in the ribbon bar and then uncheck the Visible Labels option for Joints, Members and 2D Elements.

Now labeling is turned off and it is easier and faster to control the model.

The finite element mesh, without labeling, is shown in the image below.

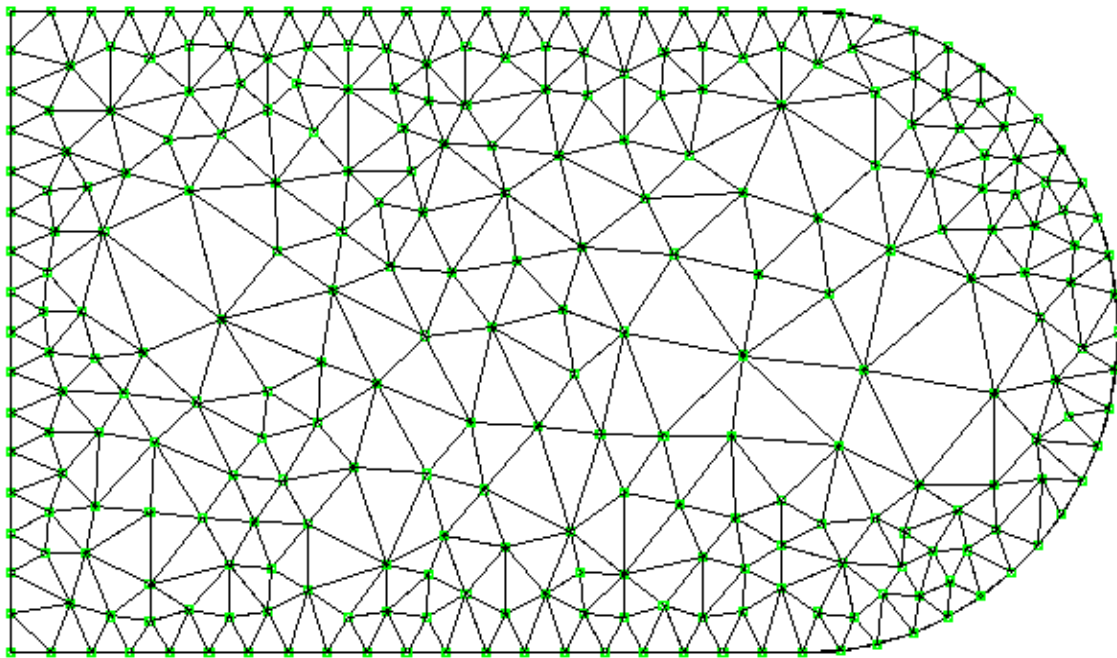

4.5. Create the walls of the tank

Step #58. Generate the finite elements that will model the Wall of the Tank by extruding the polyline: Click on the icon  **3D Extrude** (Note: the display of joints and elements previously created is automatically turned off to make selection of the polyline and extrude line easier). When the prompt message *Select Line, Arc, Circle or PolyLine to be Extruded* appears, click on the Polyline that you have created in a previous step, as shown in the following picture (Click #1).

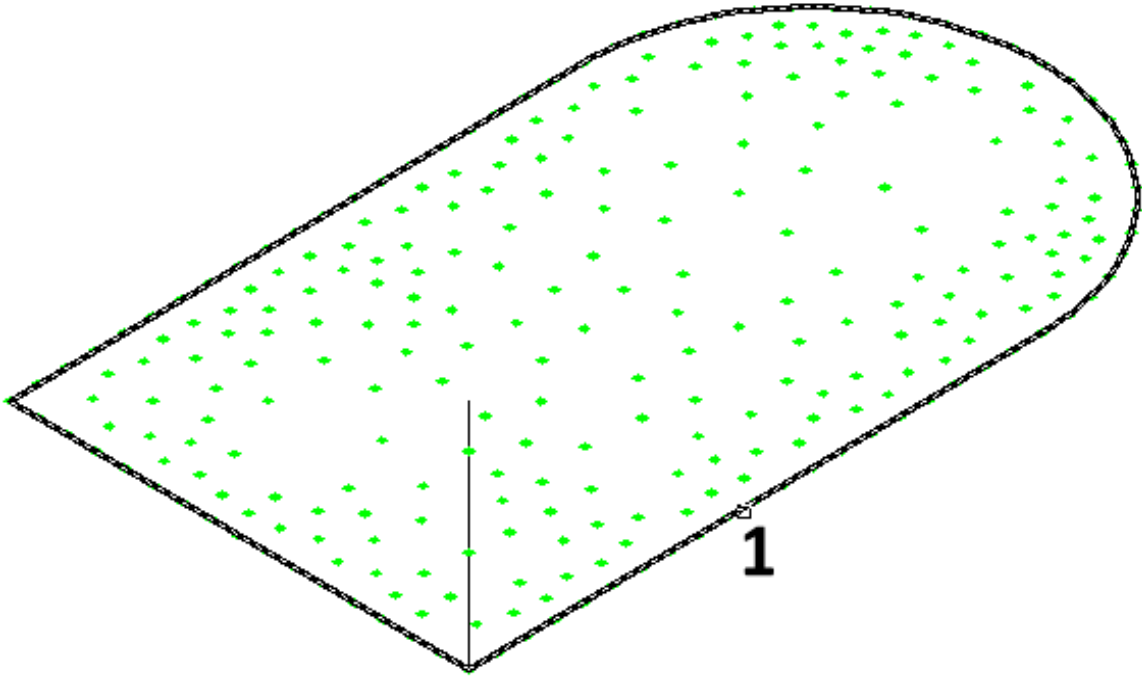

When the prompt message *Select Extrude Direction Curve (Line or Arc)* appears, click on the line that you have created in a previous step, as shown in the picture below (Click #2).

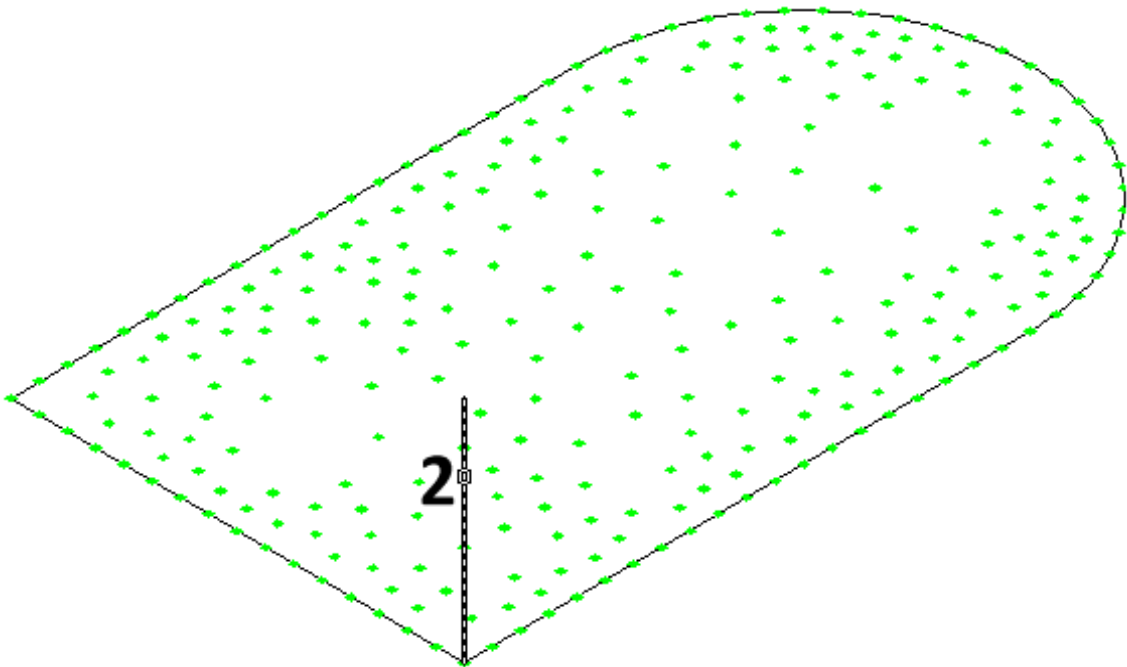

The Select Mesh Properties form appears where you have to enter:

- Material : *Concrete*
- Type: *SBHQ6*, meaning quad elements having 6 degrees of freedom per node
- Thickness: *0.2*
- Boundary Maximum Edge Size: *0.5*
(Note: This must be the same as when the mesh in the bottom of the tank was created so the mesh will be the same along the polyline)
- Mesh Quality: *High*
- *Spacing Extrude Direction: Uniform and select 8 spaces in the pulldown*

You can press the Preview button to see the finite elements as they will be generated.

Press the Create button to generate the finite elements and joints on the wall of the tank

The finite element mesh is presented in the following image.

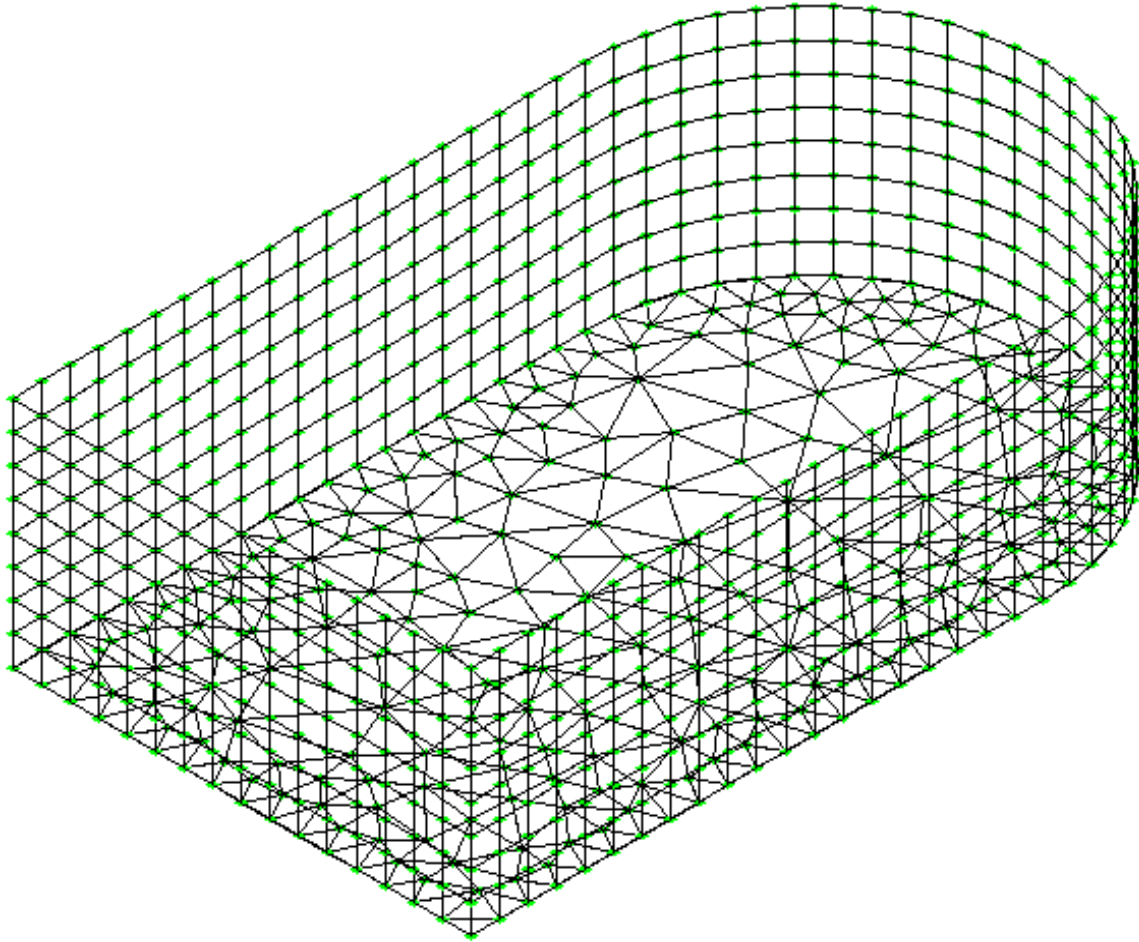

Step #59. Check for duplicate joints: Since both meshing functions described above generated joints along the polyline, pairs of joints having the same coordinates exist in the model and they have to be merged together. In order to check for joints having the same coordinates, click on the icon  **Locate Duplicates** under the **Joints** panel.

For the *Merge Accuracy* $<0.001000>$, just press $<ENTER>$ to accept the default value.

The Merge Joints form appears where you can see the list of joints having the same coordinates. Make sure that Merge option is checked for all joint pairs and press OK.

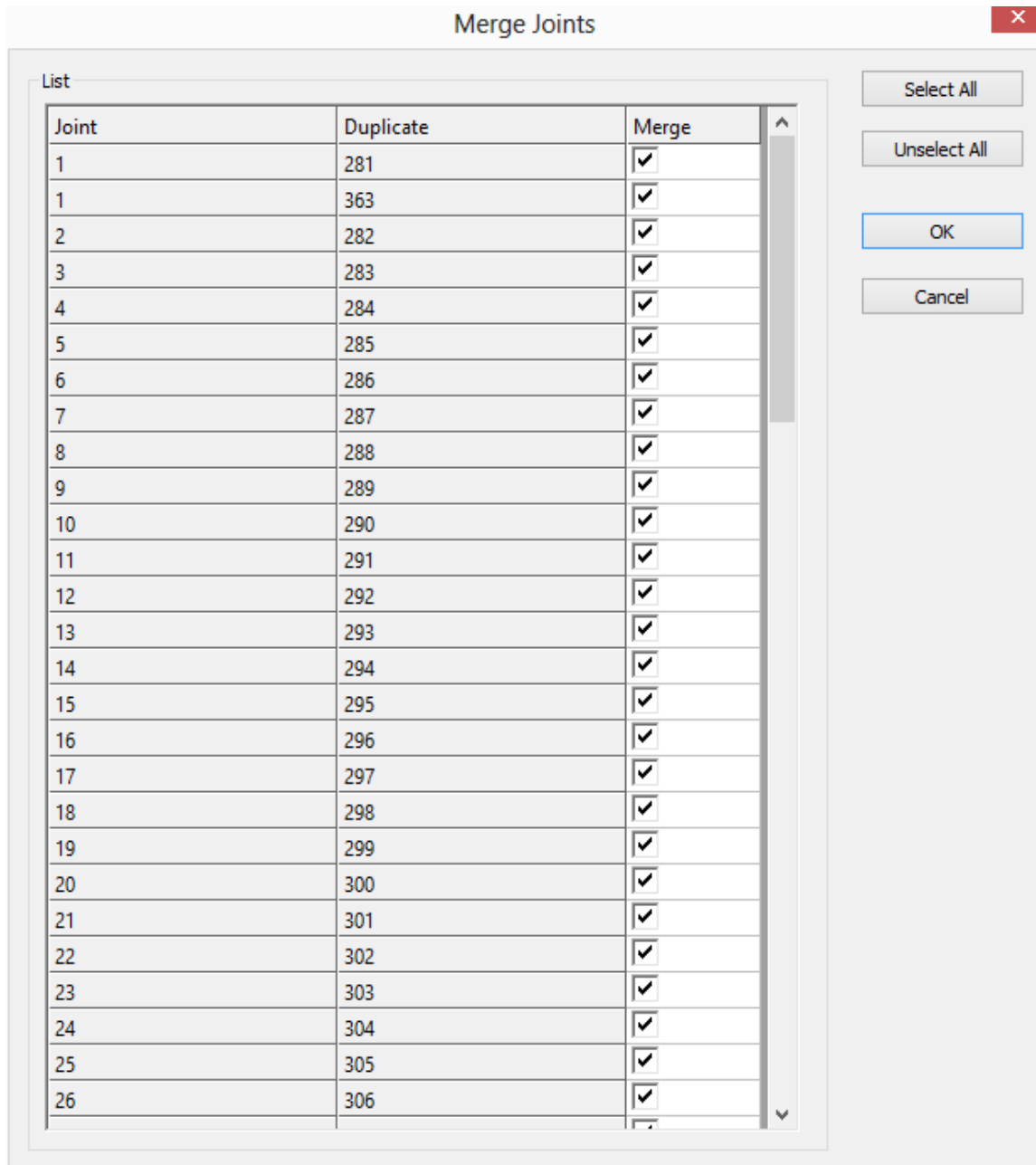

By entering the same command again for the 2nd time, you should get the notification that *0 duplicate joints found* .

Step #60. Switch to 3D View: Press the house icon to change the view to Isometric, and type Z and E (Zoom, Extents). Click on the icon  **Options** to set a different color for 2D finite elements. When the Display Options form appears, click on the white button next to “2D Element”, to define a different color. Using this form you can also define Object Sizes in the current length units.

Display Options ✕

<p>Visible Objects</p> <p><input checked="" type="checkbox"/> Joints </p> <p><input checked="" type="checkbox"/> Members </p> <p><input checked="" type="checkbox"/> 2D Elements </p> <p><input checked="" type="checkbox"/> 3D Elements </p>	<p>Visible Labels</p> <p><input type="checkbox"/> Joints </p> <p><input type="checkbox"/> Members </p> <p><input type="checkbox"/> 2D Elements </p> <p><input checked="" type="checkbox"/> 3D Elements </p>
<p>Label Settings - Font Sizes</p> <p>Joints : <input style="width: 50px;" type="text" value="0.250000"/></p> <p>Members : <input style="width: 50px;" type="text" value="0.250000"/></p> <p>2D Elements : <input style="width: 50px;" type="text" value="0.250000"/></p> <p>3D Elements : <input style="width: 50px;" type="text" value="0.250000"/></p> <p>Annotation : <input style="width: 50px;" type="text" value="0.250000"/></p> <p>Load Values : <input style="width: 50px;" type="text"/> <input style="width: 50px;" type="text" value="0.250000"/></p>	<p>Object Sizes</p> <p>Joint : <input style="width: 50px;" type="text" value="0.050000"/></p> <p>Load Arrowhead : <input style="width: 50px;" type="text" value="0.150000"/></p>
<p>Scale Factors</p> <p>Concentrated Load : <input style="width: 50px;" type="text" value="0.100000"/></p> <p>Distributed Load : <input style="width: 50px;" type="text" value="0.100000"/></p>	
<p><input type="button" value="OK"/> <input type="button" value="Cancel"/></p>	

Select Color ✕

Index Color

AutoCAD Color Index (ACI):

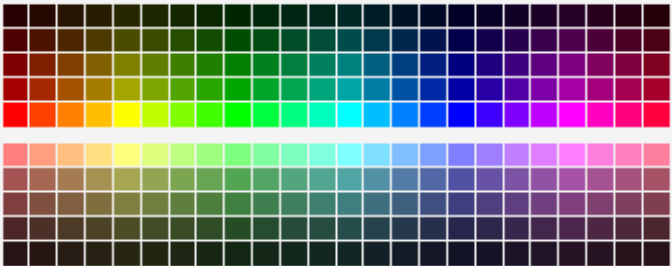

Color:

Press OK to close the Color Options Dialog. The elements will now have the color that you selected .

Press the icon  3D to display the 3D solid view of the model, replacing the wireframe view:

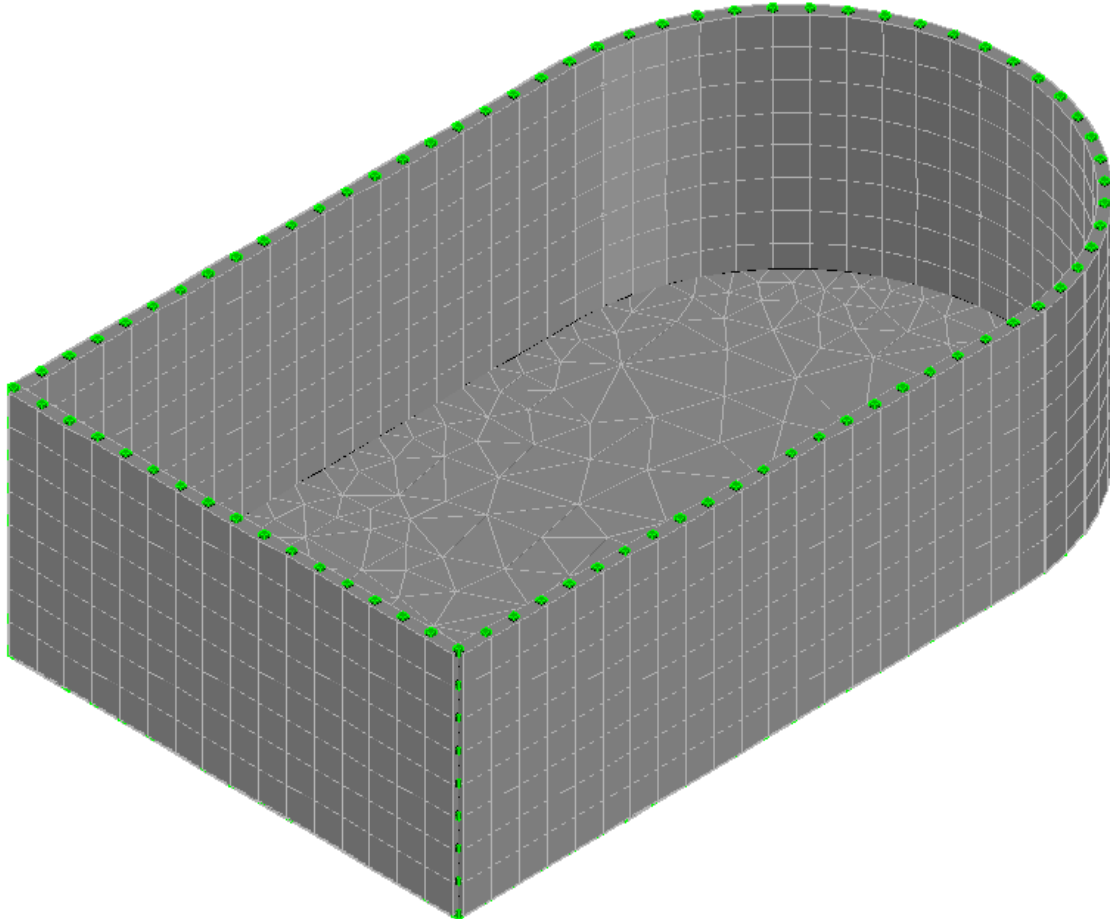

Press the icon  Frame to switch back to wireframe view to be able to process CAD Modeler's and AutoCAD's commands faster.

Step #61. Save your Model: In order to save your model, use AutoCAD's save command and store the DWG using any filename that you want.

4.6. Create Supports

Step #62. Support the joints at the base of the model:

Switch to the FRONT View, by clicking on Front on AutoCAD's view cube.

Click on the icon  Support and select the window by clicking at points 1 and 2 in the following image. All the bottom joints are selected and press OK to finish the selection.

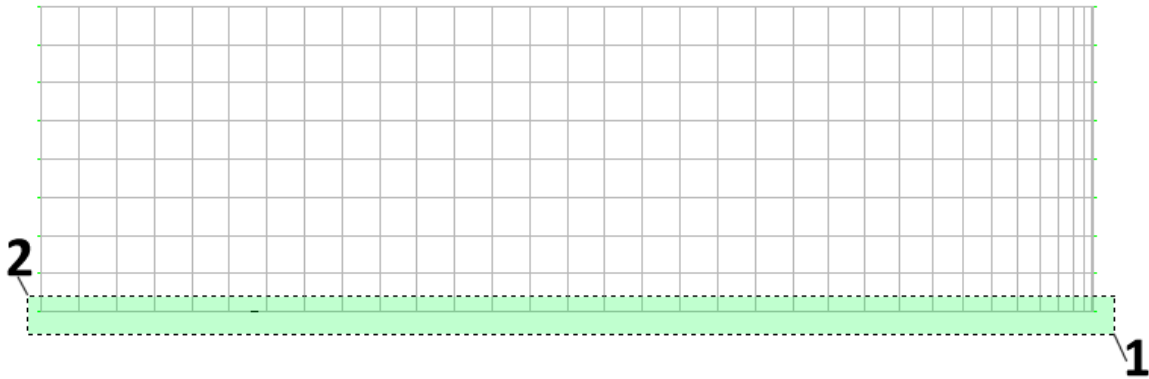

Restraints & Spring values

Quick Selection : Pin ▼

Restraint	Spring	Restraint	Spring
<input checked="" type="checkbox"/> Fx	<input type="text"/>	<input type="checkbox"/> Mx	<input type="text"/>
<input checked="" type="checkbox"/> Fy	<input type="text"/>	<input type="checkbox"/> My	<input type="text"/>
<input checked="" type="checkbox"/> Fz	<input type="text"/>	<input type="checkbox"/> Mz	<input type="text"/>

The Joint Properties [Multiple Selection] form appears.

Using the Quick Selection, select Pin and note that Fx, Fy and Fz are automatically checked.

Press OK.

Press the house icon to change the view to Isometric, and type Z and E (Zoom, Extents).

All the bottom joints are now pinned and have an orange color instead of green to indicate that they are supported.

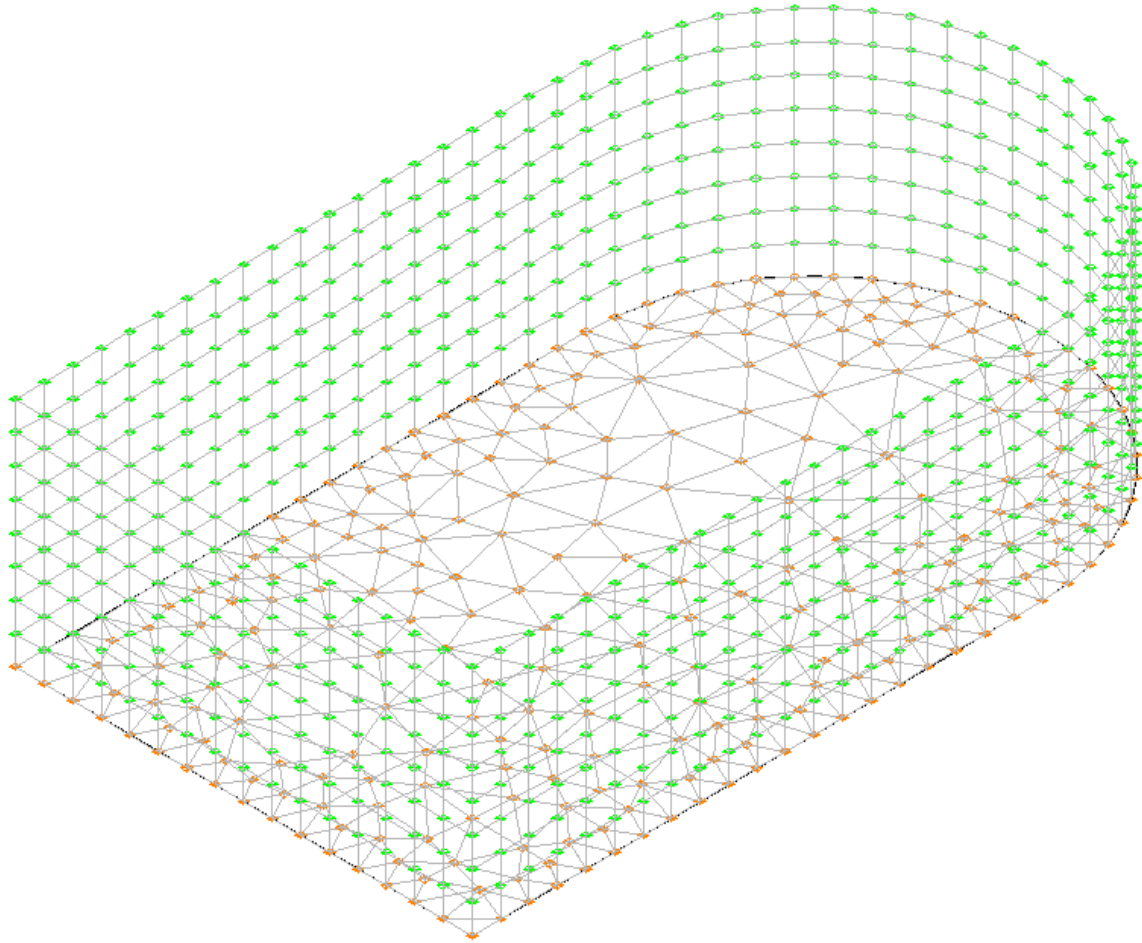

4.7. Check the model

Step #63. Check for duplicate joints: In order to check for joints having the same coordinates, click on the icon  **Locate Duplicates** under the **Joints** panel.

For the Merge Accuracy <0.001000>, just press <ENTER> to accept the default value.

You should get the notification that *0 duplicate joints found*.

Step #64. Check for floating joints: In order to check for joints not connected to the model, click on the icon  **Locate Floatings** under the **Joints** panel. If your model was created as described so far, you should get a notification that *0 floating joints found*.

4.8. Define Groups

Step #65. Create Group Names: It is optional to define Groups in your model but it is strongly recommended to do so since it will be easier to control the display and selection for parts of your structure.

In the Group panel, click on the icon  **List** and the Group dialog appears.

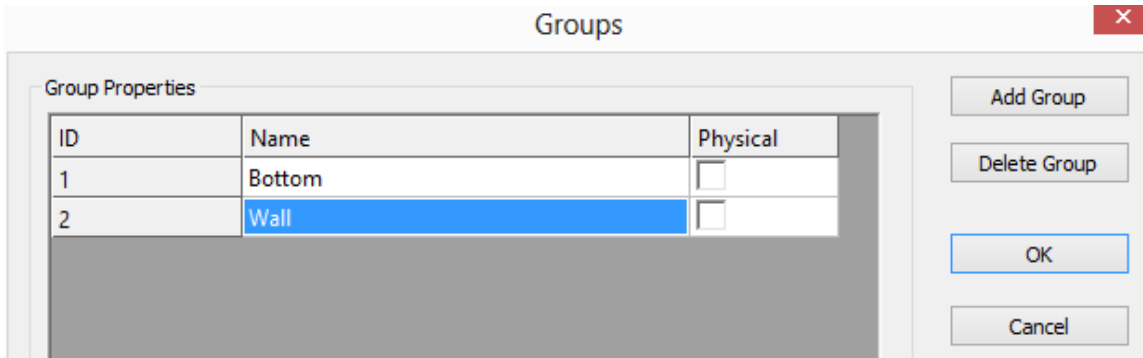

Press the *Add Group* button and enter `Bottom` as *Name* of the group.

Press the *Add Group* button and enter `Wall` as *Name* of the group.

Press *OK* to close the form.

Step #66. Add the elements in the bottom of the tank to the Group `Bottom`:

Switch to the *FRONT* View, by clicking on *Front* on AutoCAD's view cube.

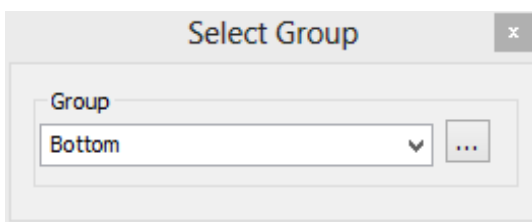

Click on the icon  `+Shells` in the Group panel and make sure that the Group `Bottom` is selected as the active group.

Make a selection by clicking at the points 1 and 2 of the following image and press the *Enter* key.

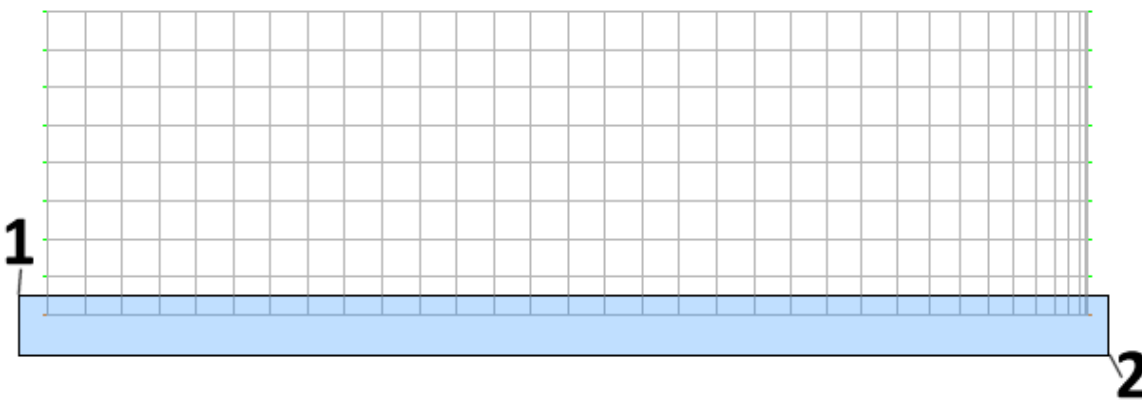

All the shell elements located in the bottom of the tank are now selected and added to group `"Bottom"`.

Step #67. Add the elements in the tank wall to the Group Wall.

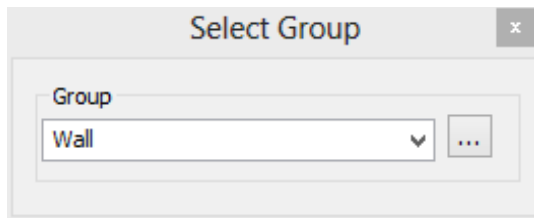

Click on the icon  +Shells and make sure that the Group Wall is selected as the active group.

Make a selection by clicking at the points 1 and 2 of the following image and press the Enter key.

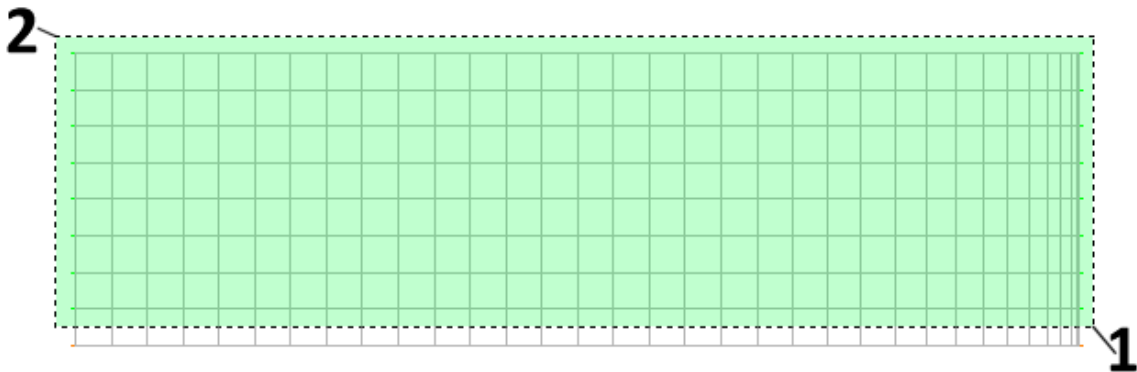

All shell elements located in the wall of the tank are now selected and added to group "Wall".

To verify that the group is applied correctly, you can double click on a element in the wall and in the Shell Properties form, you will be able to see its Group definition in the Shell Properties form.

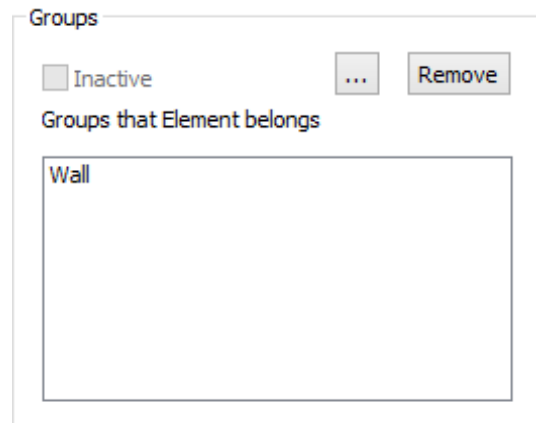

Press the house icon to change the view to Isometric, and type Z and E (Zoom, Extents).

Click at the icon  3D to display the 3D solid view as shown in the following image and save your model.

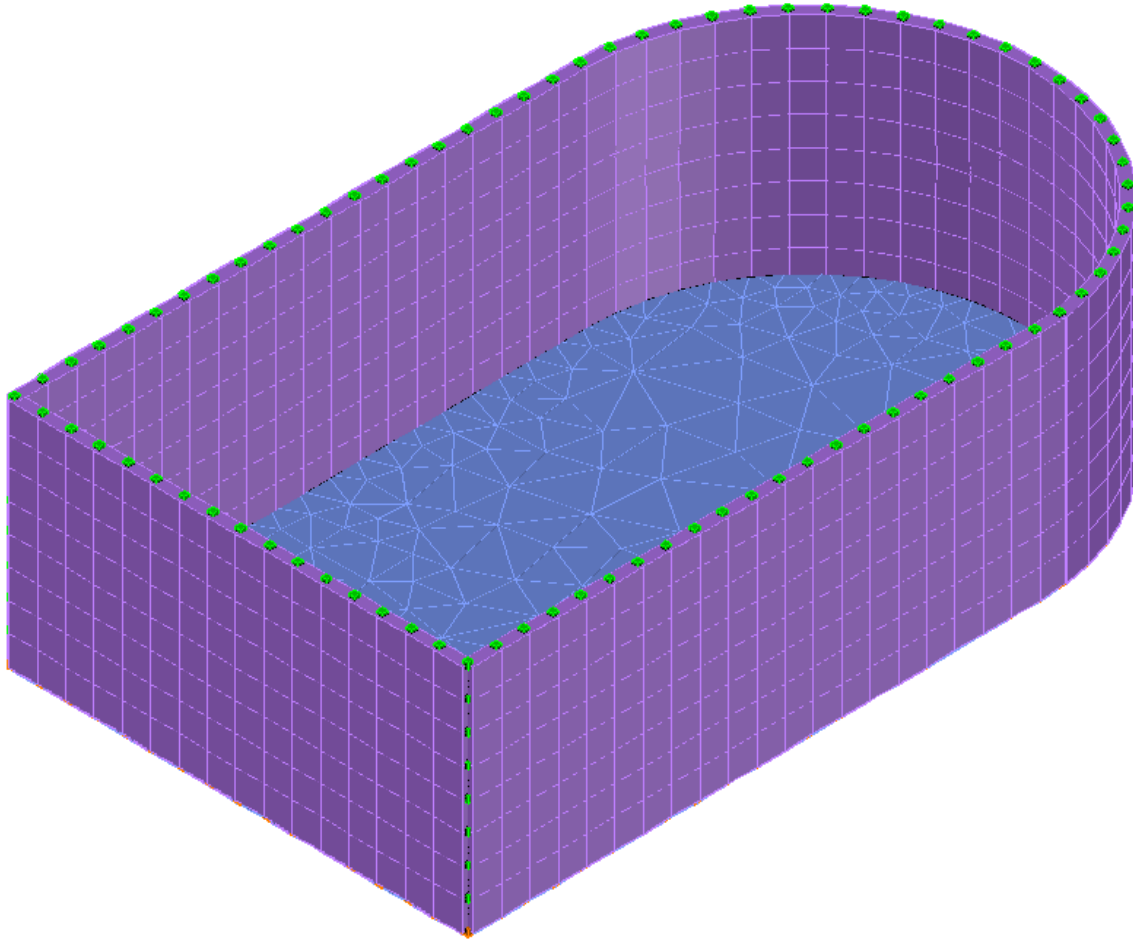

4.9. Define Loads

Step #68. Define Self Weight: Click on the icon  **Self Weight** and the Self Weight dialog appears.
Enter:

- *SW* as Name
- *Self Weight* as the Load Description
- *Negative Z* as the Global Axis for the direction of the load
- 1.0 as Factor
- Check Include finite elements

and press Create New to create the new loading and then Exit to close the dialog.

Self Weight or Dead Loads ✕

Load Information

Load ID : Create New

Name : Save / Modify

Load Description : Delete

Loads applied parallel to this Global Axis

Negative Y Positive Y
 Negative Z Positive Z
 Negative X Positive X

Factor : Include Finite Elements

Exit

Step #69. Define Load Cases: Click on the icon  **Load Cases** and the Load dialog appears.

Enter:

- *LL* as Name
- *Live Load* as the Load Description

and press Create New.

Load Case ✕

Load Case Information

Name (up to 8 chars) : Create New

Description : Save / Modify

Load Cases List : Delete

Enter:

- *PL* as Name
- *Pressure Load* as the Load Description

and press Create New.

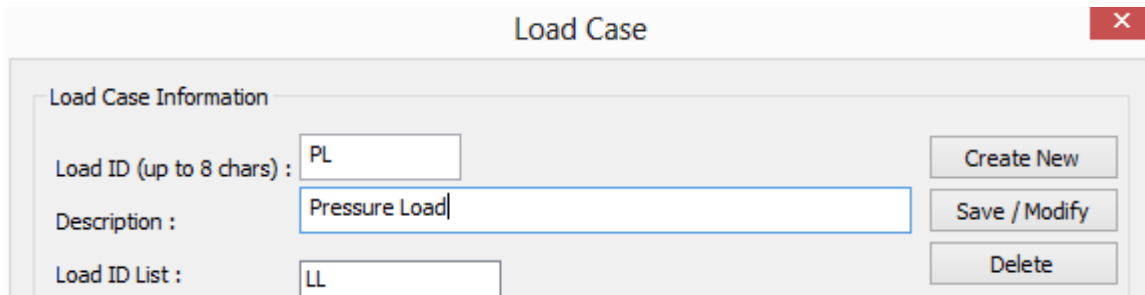

Press Exit to close the dialog.

Step #70. Apply Live Loads: Live Loads will be applied only to the bottom of the tank , therefore click on the icon  Colors . Select the 2nd Tab in order to colorize elements by their group and make only the Group Bottom visible and press OK.

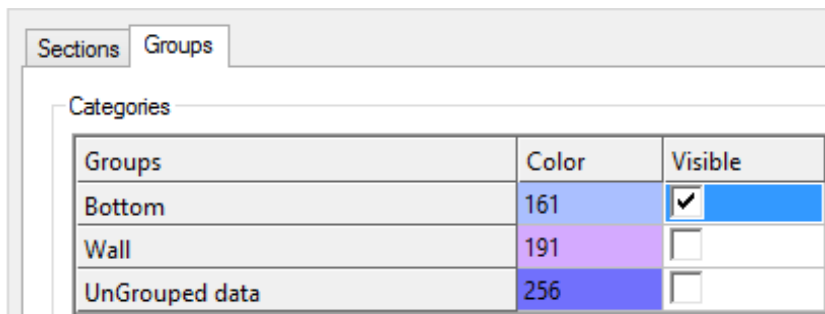

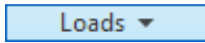
Click on the icon  Shell Load under the  panel. Using a full window, select all entities that appear on screen and press <ENTER> to finish with the selection.

The Shell Properties [Multiple Selection] form appears having the tab “Element Loads” active.

Click on LL at the “Empty Load Cases” list box and then enter:

- *Surface* as the Force Type
- *Z* as Direction
- *Global* as System
- *Uniform* as Load Distribution
- *-40* as v1

Press Create New and the number 476 appears next to the \$ symbol the Empty Load Cases list box. This is a notification that 476 elements are loaded in Load Case LL.

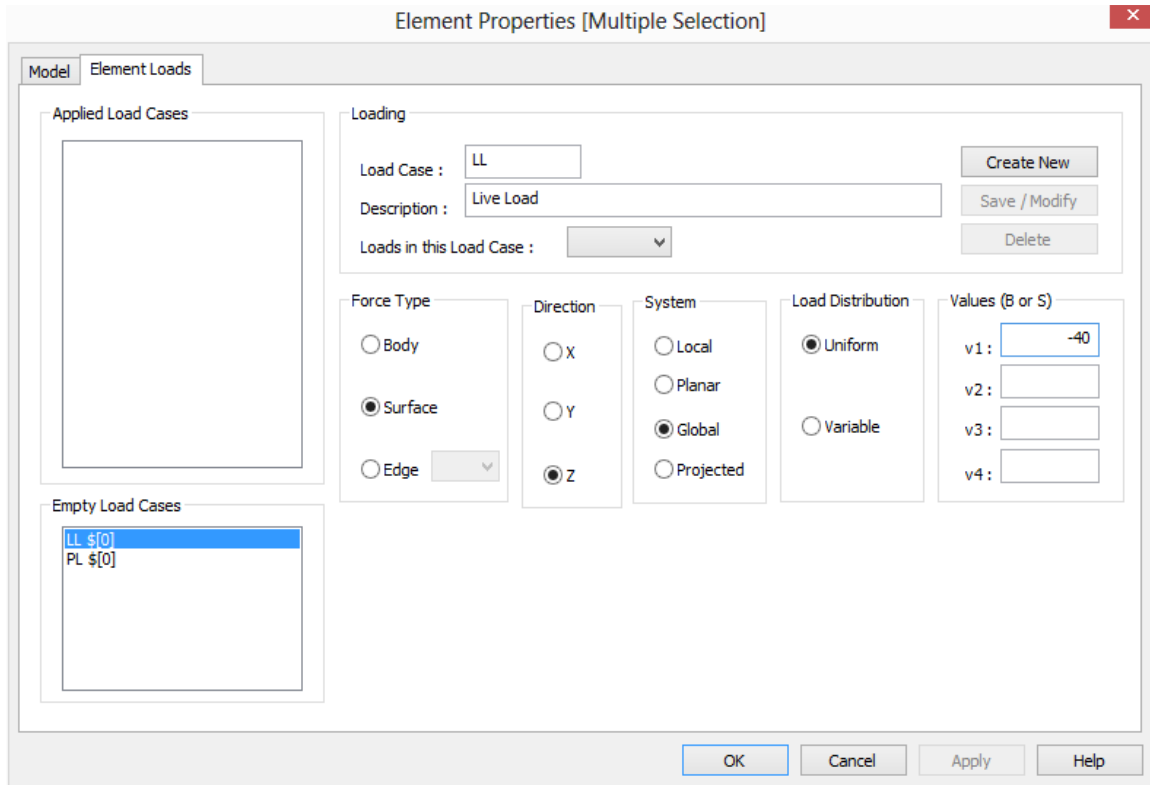

Press OK to close the dialog.

By double clicking on one element and then selecting the Element Loads tab and clicking on LL at the Applied Load Cases List Box, you will be able to view and edit the existing loading values of the specific shell.

Step #71. Apply Pressure Load: Pressure Load will be applied only to elements in the Group Wall, therefore click on the icon  Colors . Select the 2nd Tab in order to colorize elements by their group and make only the Group Wall visible and press OK.

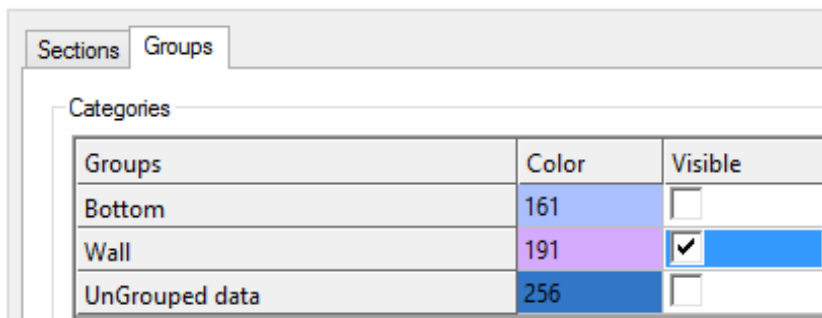

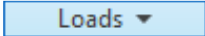
Click on the icon  Shell Load , under the  panel. Using a full window, select all entities that appear on screen and press <ENTER> to finish with the selection.

The Shell Properties [Multiple Selection] form appears having the tab “Element Loads” active.

Click on PL at the “Empty Load Cases” list box and then enter:

- *Surface* as the Force Type
- *Z* as Direction
- *Local* as System
- *Uniform* as Load Distribution
- *5* as v1

Press Create New and the number 656 appears next to the \$ symbol the Empty Load Cases list box. This is a notification that 656 elements are loaded in Load Case PL.

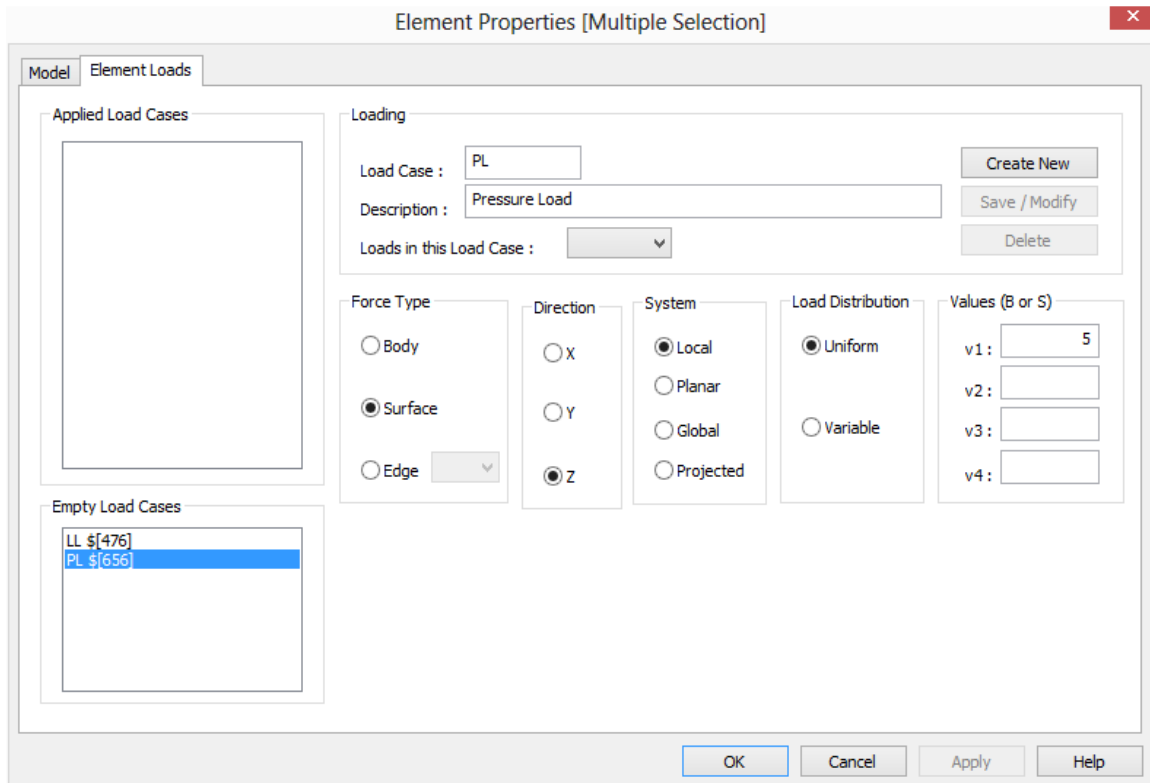

Press OK to close the dialog.

Click on the icon  Colors. Select the 2nd Tab and make everything visible.

Step #72. Define a Load Combination: Click on the icon  Load Comb. and the Load Combination dialog appears. Enter:

- *CB1* as Name
- *Load Combination 1* for the Description of the Load Combination
- Click on SW, Enter 1.3 as the factor and press ADD>>
- Click on LL, Enter 1.5 as the factor and press ADD>>
- Click on PL, Enter 1.1 as the factor and press ADD>>
- Press Store
- Press Done to close the dialog.

New Form Load or Load Combination ✕

Load Information

Name :

Description :

Type

Load Combination

Form Load

Combine

SW (Self Weight)
LL (Live Load)
PL (Pressure Load)

ADD >>

SW 1.30000
LL 1.50000
PL 1.10000

Factor :

Delete Item

STORE V

4.10. Create GT STRUDL Input File

Step #73. Create GTI: Click on the icon **Create GTI** and the Create GT STRUDL Input file dialog appears. Keep the default GTI filename, check the options “Perform Stiffness Analysis”, “Read Joint Displacements” and “Read Finite Element Results” as shown in the following image and press OK.

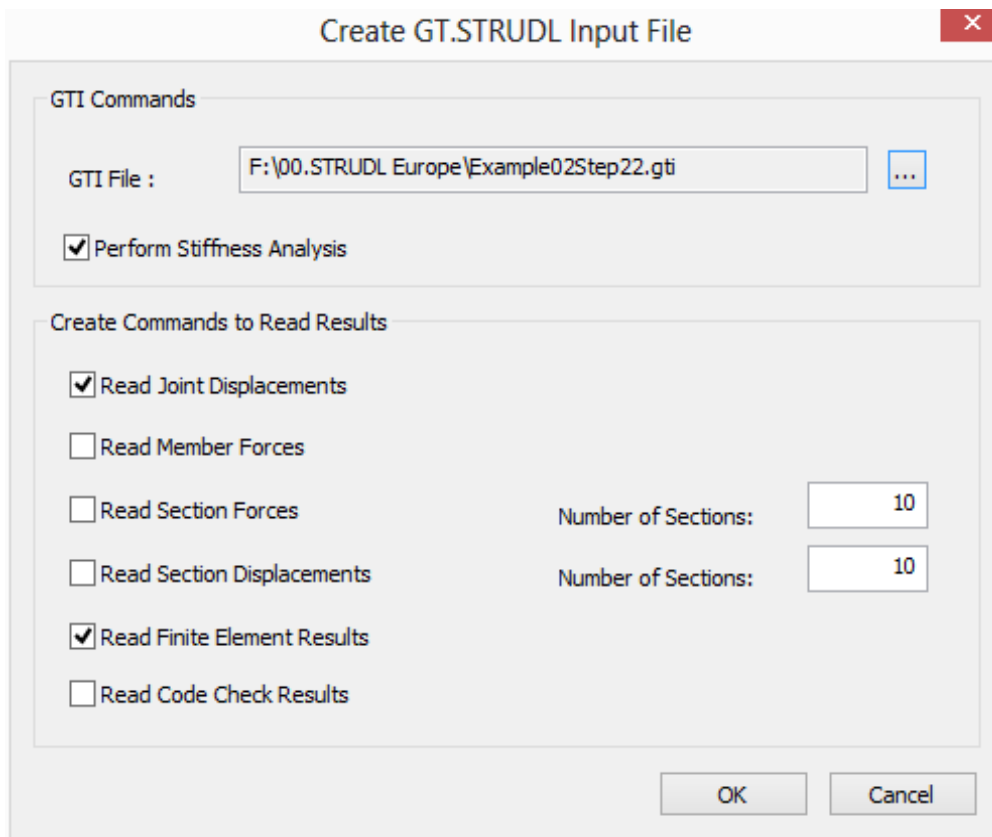



Step #74. View/Edit GTI: Click on the icon  **Edit GTI** and the GTI file created in the previous step will be opened by the system's default text editor.

Step #75. Execute GT STRUDL: Click on the icon  **Execute GT STRUDL** and the GTI file created in the previous step will be sent to GT STRUDL main program that is waiting in the background.

Stiffness analysis is automatically performed and DBX result files are automatically created.

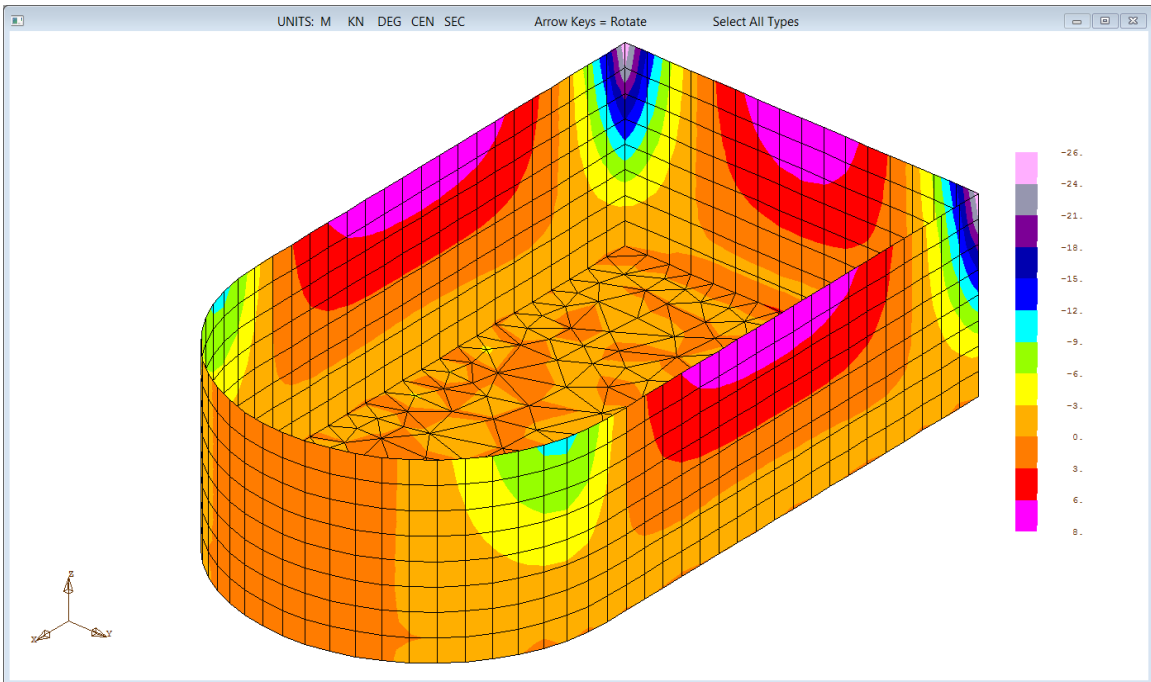
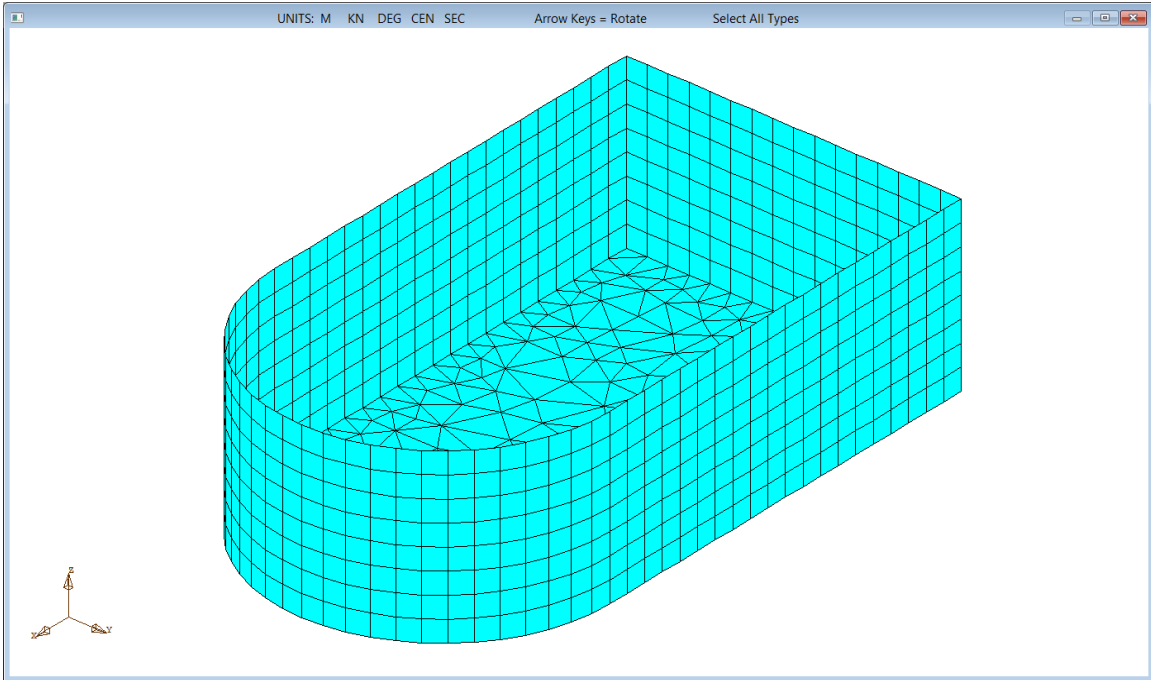
In addition, you can enter GTMENU to view the solid model and the results as described in the GTMENU User Guide. You can also click on Display > Results > Finite Element Results > Contour Sresses, Strains, Displacement and display MXX Bending Resultants for load case PL as shown in the following figures



Step #76. Read Results from GT STRUDL: Click on the icon  **Read GT STRUDL Results** and the Read GT.STRUDL Results dialog appears. Check the options “Read Joint Displacements” and “Read Finite Element Results” as shown below and press OK.

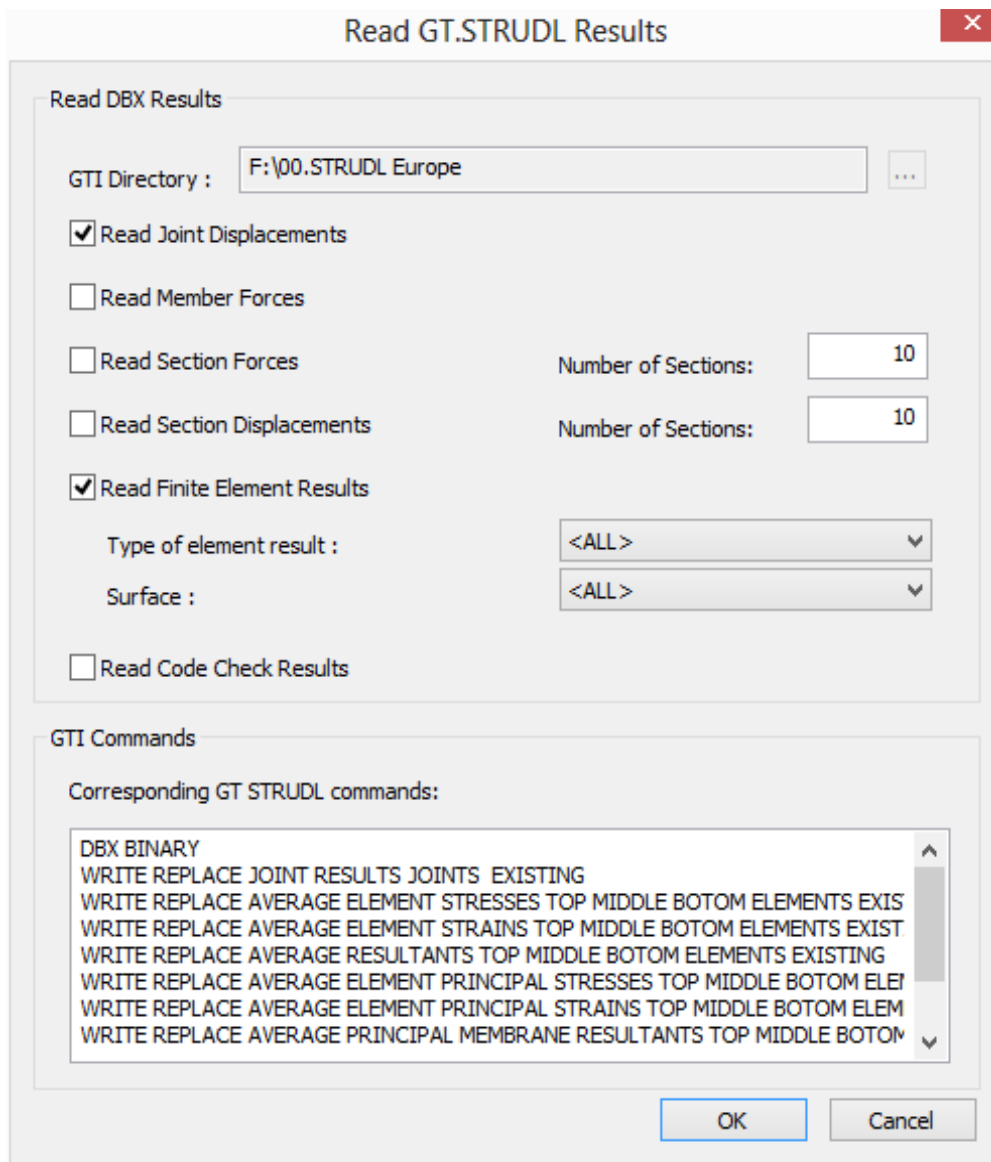

You will get the following error message at the command prompt:

```
ERROR Loading Results: The following DBX files cannot be found:
```

```
STDBX34 - Strains
```

```
STDBX37 - Principal Strains
```

This message informs you that no Strain results are available to be loaded. You can ignore this message, since the elements used (SBHQ6) do not give strains as output results.

4.11. Display Results

Step #77. Show Displacements: In the menu bar, click on GTS Display>Deformed Structure and then select PL as the load Case and press ENTER twice. The deformed structure will be drawn as shown below.

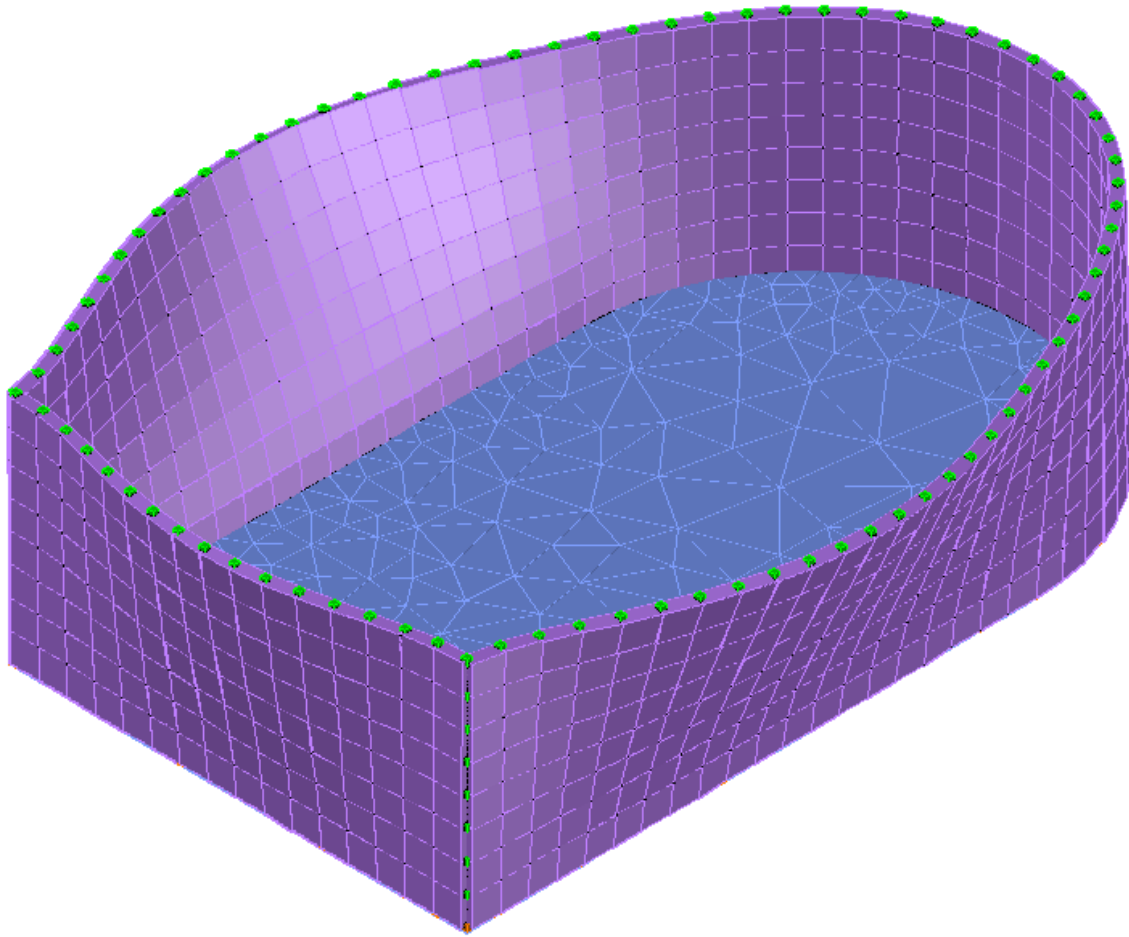

In the menu bar, click on GTS Display>Undeformed Structure to return to the original undeformed position of the model.

Step #78. Show Finite Element Results: In the menu bar, click on GTS Display>Element Results and then select PL as load Case and press ENTER.

The following command prompt message appears:

```
<33>Stress, <34>Strain, <35>Resultants, <36>Principal Stress,
<37>Principal Strain, <38>Principal Membrane Resultant,
<39>Principal Bending Resultant, <40>Von Mises
```

Type 35 and ENTER to select Resultants.

The following command prompt message appears:

```
<1>Top, <2>Middle, <3>Bottom
```

Type 2 and ENTER to select middle surface.

The following command prompt message appears:

```
<1>Nxx, <2>Nyy, <3>Nxy, <4>Mxx, <5>Myy, <6>Mxy, <7>Vxx, <8>Vyy
```

Type 4 and ENTER to select Mxx.

The multi-colored contour image of the structure is displayed and each color is corresponding to a range of Mxx values as shown in Legend Form.

I recommend deleting the next image and just show the contour with the legends form on this page.

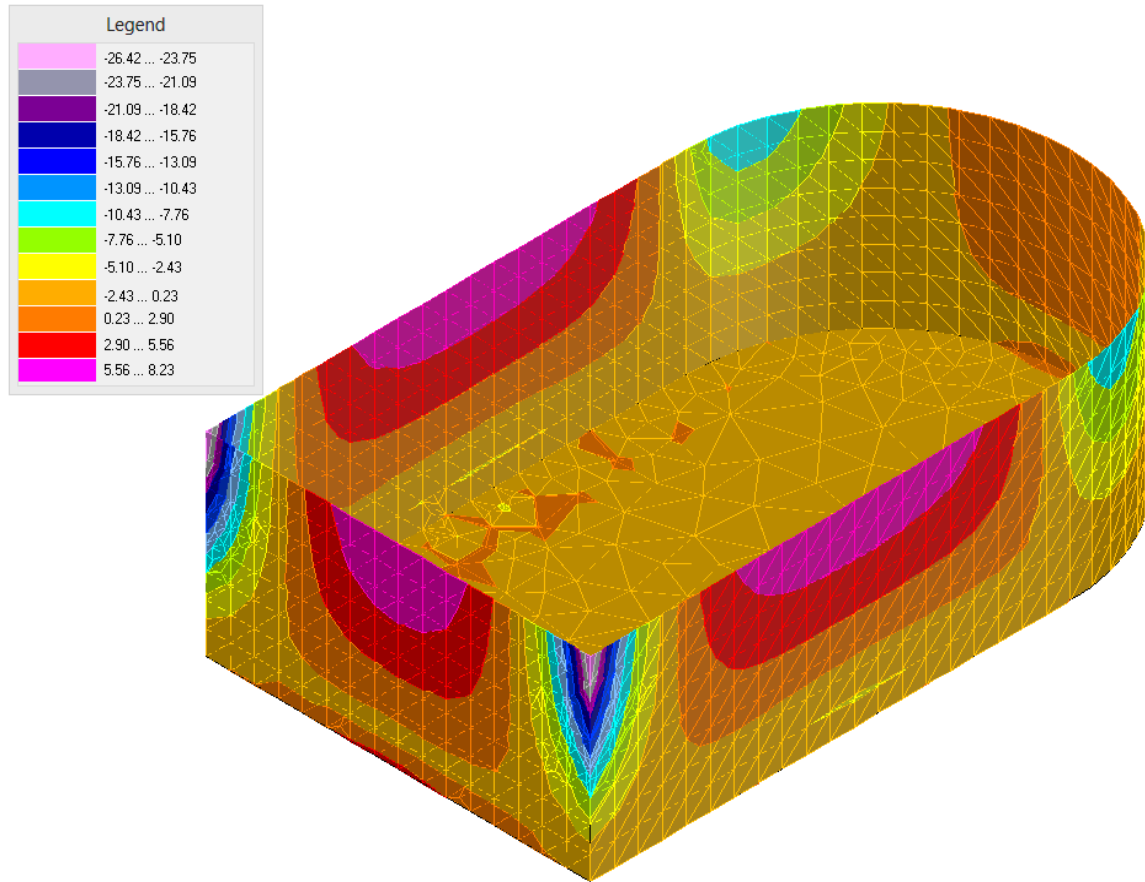

Click on the icon  **Options** to hide Joints. When the Display Options form appears, uncheck the Joints – Visible Objects and press OK. 2D Elements are already hidden, so as to display the contours.

Display Options ✕

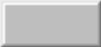
Visible Objects		Visible Labels	
<input type="checkbox"/> Joints		<input type="checkbox"/> Joints	<input type="text"/>
<input checked="" type="checkbox"/> Members	<input type="text"/>	<input type="checkbox"/> Members	<input type="text"/>
<input type="checkbox"/> 2D Elements		<input type="checkbox"/> 2D Elements	<input type="text"/>
<input checked="" type="checkbox"/> 3D Elements	<input type="text"/>	<input checked="" type="checkbox"/> 3D Elements	<input type="text"/>
Label Settings - Font Sizes		Object Sizes	
Joints :	<input type="text" value="0.250000"/>	Joint :	<input type="text" value="0.050000"/>
Members :	<input type="text" value="0.250000"/>	Load Arrowhead :	<input type="text" value="0.150000"/>
2D Elements :	<input type="text" value="0.250000"/>		
3D Elements :	<input type="text" value="0.250000"/>		
Annotation :	<input type="text" value="0.250000"/>		
Load Values :	<input type="text" value="0.250000"/>		
Scale Factors			
Concentrated Load :		<input type="text" value="0.100000"/>	
Distributed Load :		<input type="text" value="0.100000"/>	
<input type="button" value="OK"/> <input type="button" value="Cancel"/>			

In the menu bar, click on GTS Display>Clear Results Layer and the Legend Form is hidden.

Click on the icon  **Options** and make the Joints and 2D Elements Visible Objects again.

5. Appendix – List of Commands

Command	Icon	Menu	Command Prompt	Link
Units	 Units	<i>GTS Modeling>Units</i>	GTSUnits	2.5.1
Materials	 Materials	<i>GTS Modeling>Materials</i>	GTSMaterials	2.5.2
Sections	 Sections	<i>GTS Modeling>Cross Sections>Table</i>	GTSParams	2.5.3
Prismatic Sections	-	<i>GTS Modeling>Cross Sections>Prismatic</i>	GTSPrismatic	2.5.3
Levels	 Levels	<i>GTS Modeling>Levels</i>	GTSLevels	2.5.4
Higher Level	 Higher Level	-	GTSLevelUp	2.5.4
Lower Level	 Lower Level	-	GTSLevelDown	2.5.4
Grid	 Grid	<i>GTS Modeling>Grid>Create</i>	GTSGrid	2.5.5
Change Grid	 Change Grid	<i>GTS Modeling>Grid>Change</i>	GTSGridChange	2.5.5
Generate Joint	 Generate Joint	<i>GTS Modeling>Joint>Generate Joint</i>	GTSJoint	2.5.6
At Level (Joint)	 At Level	<i>GTS Modeling>Joint>Generate Joint at Level</i>	GTSJointLevel	2.5.6
Find (Joint)	 Find	<i>GTS Modeling>Joint>Find</i>	GTSFJID	2.5.7
Support	 Support	<i>GTS Modeling>Joint>Support</i>	GTSJointSupport	2.5.8
Change (Joint)	 Change	<i>GTS Modeling>Joint>Change</i>	GTSJointChange	2.5.9
Locate Duplicates	 Locate Duplicates	<i>GTS Modeling>Checks>Check for Duplicate Joints</i>	GTSCheckDuplicateJoints	2.5.10
Locate Floating	 Locate Floatings	<i>GTS Modeling>Checks>Check for Floating Joints</i>	GTSCheckFloatingJoints	2.5.11
Generate (Member)	 Generate	<i>GTS Modeling>Members>Generate Beam Members</i>	GTSBeam	2.5.12
Vertical (Member)	 Vertical	<i>GTS Modeling>Member>Generate Vertical Member</i>	GTSColumn	2.5.12
Find (Member)	 Find	<i>GTS Modeling>Member>Find</i>	GTSFMID	2.5.13

Split (Member)	 Split	GTS <i>Modeling>Member>Split Member</i>	GTSSplitMember	2.5.14
Merge (Member)	 Merge	GTS Modeling> <i>Member>Merge Members</i>	GTSMergeMembers	2.5.15
Change (Member)	 Change	GTS Modeling> <i>Member>Change</i>	GTSShellChange	2.5.16
Generate Quad	-	GTS <i>Modeling>Shell>Generate quad at joints</i>	GTSShell	2.5.17
Generate Triangle	-	GTS <i>Modeling>Shell>Generate triangle at joints</i>	GTSShellT	2.5.17
Find (Shell)	-	GTS Modeling>Shell> <i>Find</i>	GTSFeid	2.5.18
Change (Shell)	-	GTS <i>Modeling>Shell>Generate triangle at joints</i>	GTSShellChange	2.5.19
1D Curve (Meshing)	 1D Curve	GTS Modeling>Mesh <i>Generation>1D Along Line or Curve or Circle</i>	GTSMesh1D	2.5.20
2D 2Curves (Meshing)	 2D 2Curves	GTS Modeling>Mesh <i>Generation>2D Between 2 Lines or Curves</i>	GTSMesh2D2L	2.5.21
2D 4Curves (Meshing)	 2D 4Curves	GTS Modeling>Mesh <i>Generation>2D Between 4 Lines or Curves</i>	GTSMesh2D4L	2.5.22
2D Area (Meshing)	 2D Area	GTS Modeling>Mesh <i>Generation>2D Between 4 Lines or Curves</i>	GTSMesh2DPoly	2.5.23
3D Extrude (Meshing)	 3D Extrude	GTS Modeling>Mesh <i>Generation>3D Extrude PolyLine</i>	GTSExtrudePoly	2.5.24
2D 3Curves (Meshing)	 2D 3Curves	GTS Modeling>Mesh <i>Generation>3D Between 3 Lines or Curves</i>	GTSMesh3D3L	2.5.25
List (Group)	 List	GTS <i>Modeling>Groups>Manage</i>	GTSGroups	2.5.26
+Joints (Group)	 +Joints	GTS <i>Modeling>Groups>Add Joints</i>	GTSGroupJoints	2.5.26
+Members (Group)	 +Members	GTS <i>Modeling>Groups>Add Members</i>	GTSGroupMembers	2.5.26
+Shells (Group)	 +Shells	GTS <i>Modeling>Groups>Add Shells</i>	GTSGroupShells	2.5.26

Self Weight	 Self Weight	GTS Modeling>Loads>Self Weight	GTSSelfWeight	2.5.27
Load Cases	 Load Cases	GTS Modeling>Loads>Load Cases	GTSNewLoadCase	2.5.28
Load Combinations	 Load Comb.	GTS Modeling>Loads>Load Combinations	GTSLoadCombination	2.5.33
Joint Load	 Joint Load	GTS Modeling>Loads>Joint Load	GTSJointLoad	2.5.29
Member Load	 Member Load	GTS Modeling>Loads>Member Load	GTSBeamLoad	2.5.30
Shell Load	 Shell Load	GTS Modeling>Loads>Shell Load	GTSShellLoad	2.5.31
Area Load	 Area Load	GTS Modeling>Loads>Area Load	GTSAreaLoad	2.5.32
Create GTI	 Create GTI	GTS Modeling>Create GT.STRUDL GTI	GTSExportGTI	2.5.34
Edit GTI	 Edit GTI	GTS Modeling>Edit GT.STRUDL GTI	GTS>EditGTI	2.5.35
Execute GTI	 Execute GT STRUDL	GTS Modeling>Edit GT.STRUDL GTI	GTSExecuteGTI	2.5.36
Read GTSTRUDL Results	 Read GT STRUDL Results	GTS Modeling>Read GTSTRUDL Results	GTSResultsGTI	2.5.37
Import GTI	-	GTS Modeling>Import>GT.STRUDL GTI	GTSGTIRead	2.5.38
Set View	 Set View	GTS Display>Set View	GTSSetView	2.5.39
3D View	 3D	GTS Display>3D Sections	GTSSet3D	2.5.40
Frame View	 Frame	GTS Display>Frame	GTSSet1D	2.5.40
All (View)	 All	GTS Display>Whole Structure	GTSSetAllVisible	2.5.40
Options (View)	 Options	GTS Display>Options	GTSDisplay	2.5.42
Colors	 Colors	GTS Display>Colors	GTSColorView	2.5.41
Annotate	 Annotate	GTS Display>Annotate	GTSAnnotate	2.5.43
Select	 Select	-	GTSSelect	2.5.44
Deformed Structure	-	GTS Display>Deformed Structure	GTSDisplayJointDisplacements	2.5.45
Deformed Structure	-	GTS Display> Udeformed Structure	GTSDisplayJointDisplacements	2.5.45

Joint Loads (display)	-	<i>GTS Display>Joint Loads</i>	GTSDisplayJointLoads	<u>2.5.46</u>
Member Loads (display)	-	<i>GTS Display>Member Loads</i>	GTSDisplayMemberLoads	<u>2.5.47</u>
Member Diagrams	-	<i>GTS Display>Member Diagrams</i>	GTSDisplayMemberForces	<u>2.5.48</u>
Finite Element Results	-	<i>GTS Display>Element Results</i>	GTSDisplayElementResults	<u>2.5.49</u>
Member Code Check Results	-	<i>GTS Display>Member Code Check Results</i>	GTSColorCodeCheck	<u>2.5.50</u>
Clear Results	-	<i>GTS Display>Clear Results Layer</i>	GTSDisplayResultsClear	<u>2.5.51</u>
Current Version	-	<i>GTS Display>Version</i>	GTSVersion	<u>2.5.52</u>